

CREAM- titanium dioxide, zinc oxide lotion
OXYGEN DEVELOPMENT, LLC

Disclaimer: Most OTC drugs are not reviewed and approved by FDA, however they may be marketed if they comply with applicable regulations and policies. FDA has not evaluated whether this product complies.

**SUGAR RUSH SKIN TREAT PORELESS TINTED MOISTURIZER BROAD SPECTRUM
SPF 20 SUNSCREEN - MEDIUM**

Active Ingredients

Titanium Dioxide 4.55%

Zinc Oxide 3.5%

Purpose

Sunscreen

Uses

- Helps prevent sunburn.
- If used as directed with other sun protection measures (see Directions) decreases the risk of skin cancer and early skin aging caused by the sun.

Warnings

For external use only

Stop use and ask doctor if rash occurs.

Do not use on damaged or broken skin.

When using this product keep out of eyes. Rinse with water to remove.

Keep out of the reach of children. If swallowed, get medical help or contact a Poison Control Center right away.

Directions

- Shake before use.
- Apply liberally 15 minutes before sun exposure.
- Use a water-resistant sunscreen of swimming or sweating.
- Reapply at least every 2 hours.
- Children under 6 months: Ask a doctor.
- **Sun Protection Measures.** Spending time in the sun increases our risk of skin cancer and early skin aging. To decrease this risk regularly use a sunscreen with a Broad-Spectrum SPF value of 15 or higher and other sun protection measures including:

Limit time in the sun, especially from 10 a.m.- 2p.m.

Wear long-sleeved shirts, pants, hats and sunglasses.

Other information

- Protect the product in this container from excessive heat and direct sunlight.
- You may report a serious adverse reaction to: tarte c/o Report Reaction, LLC, P.O. Box 22, Plainsboro, NJ 08536-0222.

Inactive Ingredients

Cyclopentasiloxane, Isododecane, Mica, Polysilicone-11, Polymethylsilsesquioxane, Hexyl Laurate, PEG-10 Dimethicone, Polyglyceryl-4 Isostearate, Stearic Acid, Cetyl PEG/PPG-10/1 Dimethicone, Alumina, Triethoxycaprylylsilane, Dipalmitoyl Hydroxyproline, Diamond Powder, Iron Oxides.

Primary Package (Inner)

sugar  rush	
SUB-BRAND: SUGAR RUSH	FILE NAME: 01541CO-2 GG SKIN TREAT
COMPONENT: PRIMARY	SHADE: SPF
DATE OPENED: 8/7/20	DATE REVISED:
REASON FOR CHANGE: PRODUCTION	
COLORS	
 BLACK 705C CLEAR	
TUBE FINISH: MATTE	

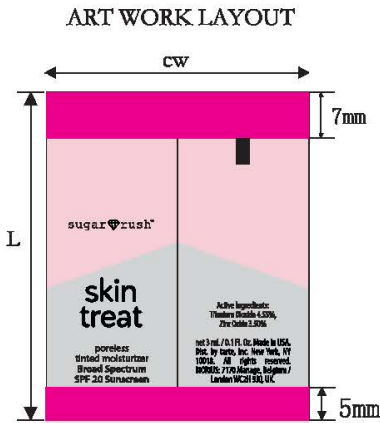

- F: front panel width B: back panel width
- CW: circumferential width
- L: tube length (from shoulder to bottom)
- Eyemark (2×4 mm): mark for end sealing
- Upper edge(7mm): space for end sealing
- Bottom edge(5mm): non-printing space

Dia 13×L50 shadow area:	F/B 20mm	CW 40mm	L(changeable) 50mm
	printing area		

Secondary Package (Outer)

3ml, 61354-051-41

sugar  rush	
SUB-BRAND: SUGAR RUSH	FILE NAME: 01541CO-2 GG SKIN TREAT SPF
COMPONENT: ZIP BAG	SHADE: MEDIUM
DATE OPENED: 9/1/20	DATE REVISED:
REASON FOR CHANGE:	
COLORS	
■ 9120C ■ WHITE ■ BLACK ■ CLEAR	
FINISH: GLOSSY	

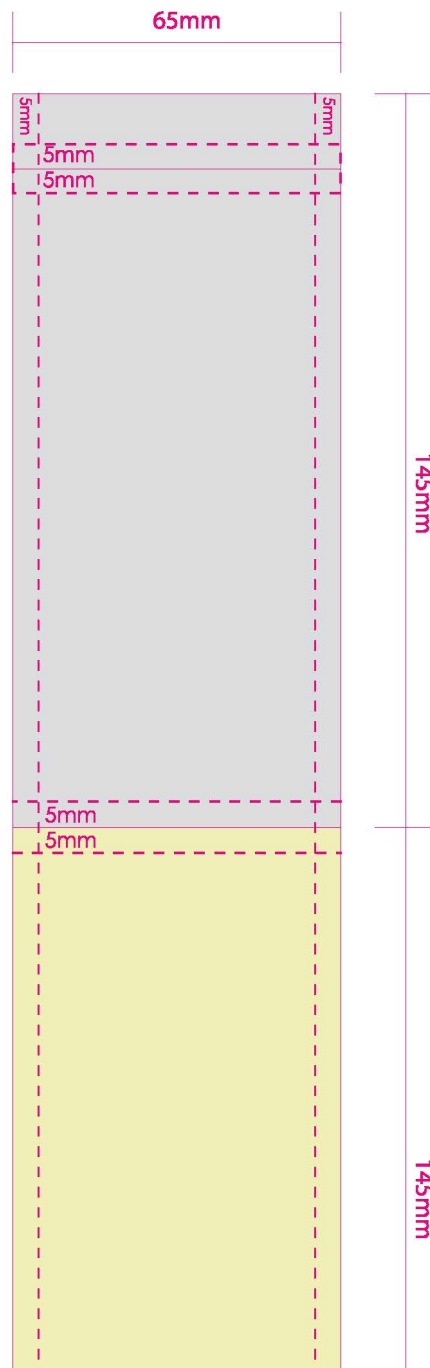
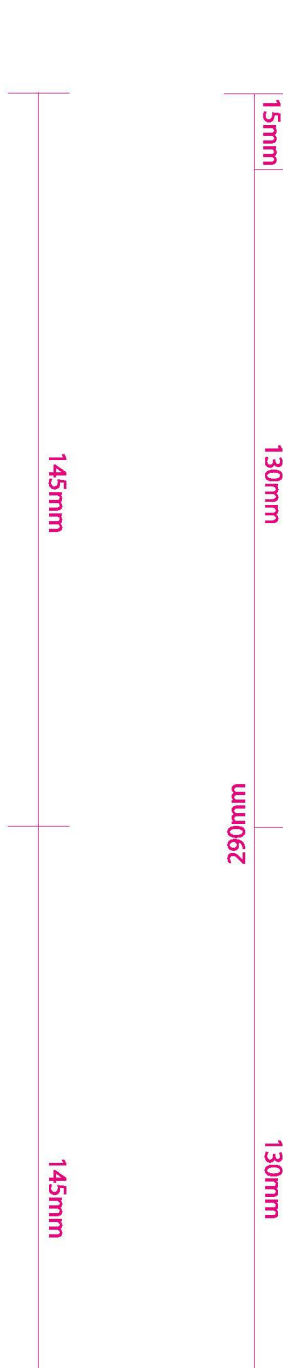
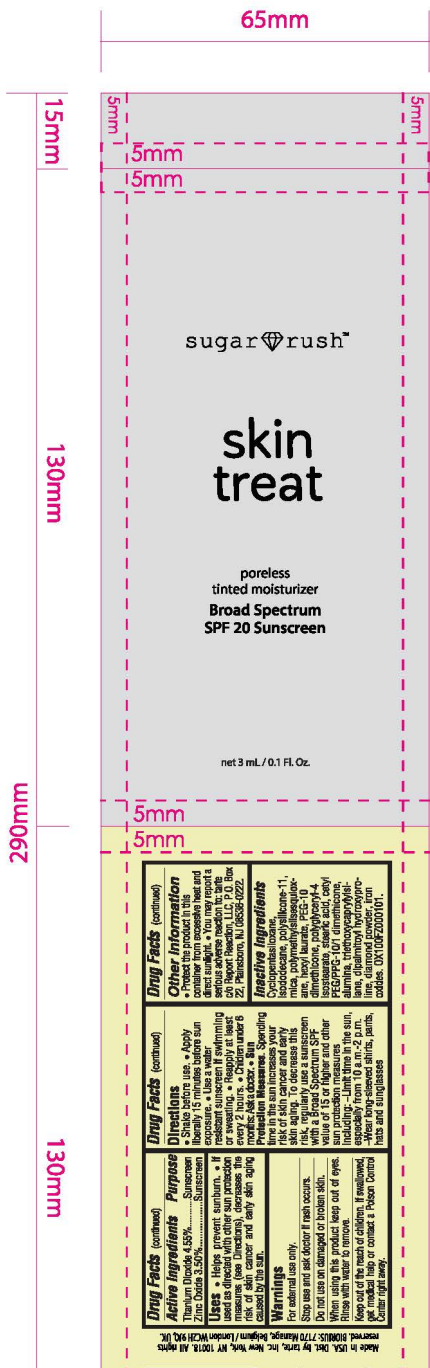

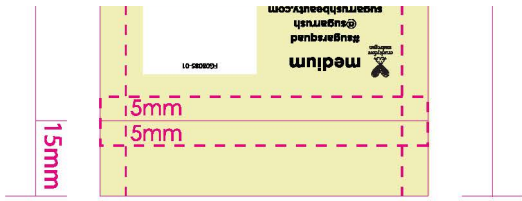

	12mm	
8mm	light	SP 12646
	medium	SP 12647
	tan	SP 12648
	deep	SP 12649

Primary Package(10ml)

10ml, 61354-051-42

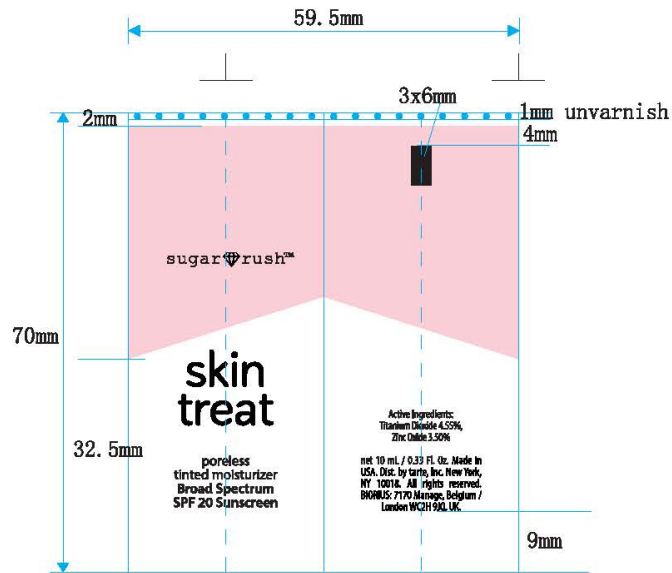

320479 (3) 丝网印 (Silkscreen): black 705c
 树脂印 (Offset printing): black
 white (white offset underneath 705c)

- black
- white (white offset underneath 705c)
- black
- 705c
- die line, does not print
(边框, 不印刷)
- unvarnished area

产品编号 P/N	320479 (3)	制作人 Processed by	Mary	确认签字 Approval	
打样/订单号 Sample/PO #		制作日期 Date	2020/08/20	日期 Date	
附加说明 Remarks					

Secondary Package(10ml)

10ml, 61354-051-42

sugar  rush	
SUB-BRAND: SUGAR RUSH	FILE NAME: 00913CO-3 TRAVEL SIZE SKIN TREAT SPF
COMPONENT: SEC	SHADE: MEDIUM
DATE OPENED: 8/12/20	DATE REVISED:
REASON FOR CHANGE: NEW DIELINE	
COLORS	
<input checked="" type="checkbox"/> 9120C <input type="checkbox"/> WHITE <input checked="" type="checkbox"/> BLACK	
<input checked="" type="checkbox"/> 9120C INTERIOR PRINTING	
PAPER: FSC FINISH: MATTE	

P025709

SIZE:86*33*33(mm)

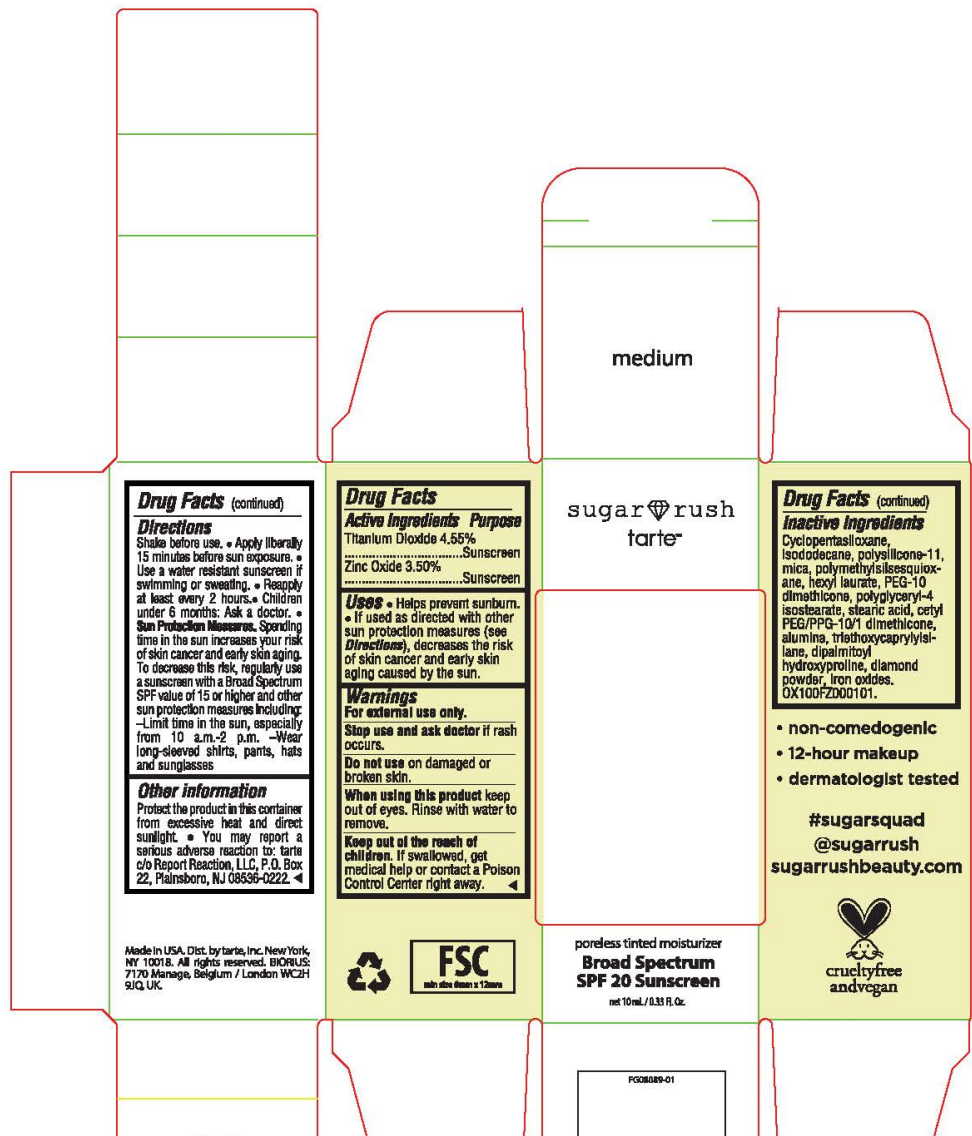

CREAM

titanium dioxide, zinc oxide lotion

Product Information

Product Type	HUMAN OTC DRUG	Item Code (Source)	NDC:61354-051
Route of Administration	TOPICAL		

Active Ingredient/Active Moiety

Ingredient Name	Basis of Strength	Strength
ZINC OXIDE (UNII: SOI2LOH54Z) (ZINC OXIDE - UNII:SOI2LOH54Z)	ZINC OXIDE	3.5 mg in 100 mg
TITANIUM DIOXIDE (UNII: 15FIX9V2JP) (TITANIUM DIOXIDE - UNII:15FIX9V2JP)	TITANIUM DIOXIDE	4.55 mg in 100 mg

Inactive Ingredients

Ingredient Name	Strength
POLYMETHYLSILSESQUIOXANE (11 MICRONS) (UNII: Z570VEV8XK)	
HEXYL LAURATE (UNII: 4CG9F9W01Q)	
ISODODECANE (UNII: A8289P68Y2)	
MICA (UNII: V8A1AW0880)	
POLYGLYCERYL-4 ISOSTEARATE (UNII: 820DPX33S7)	
PEG-10 DIMETHICONE (600 CST) (UNII: 8PR7V1SVM0)	
STEARIC ACID (UNII: 4ELV7Z65AP)	
DIMETHICONE/VINYL DIMETHICONE CROSSPOLYMER (SOFT PARTICLE) (UNII: 9E4CO0W6C5)	
CYCLOMETHICONE 5 (UNII: 0THT5PCI0R)	

Packaging

#	Item Code	Package Description	Marketing Start Date	Marketing End Date
1	NDC:61354-051-42	1 in 1 CARTON	03/05/2021	
1		10 mg in 1 TUBE; Type 0: Not a Combination Product		
2	NDC:61354-051-41	1 in 1 CARTON	03/05/2021	
2		3 mg in 1 TUBE; Type 0: Not a Combination Product		

Marketing Information

Marketing Category	Application Number or Monograph Citation	Marketing Start Date	Marketing End Date
OTC monograph final	part352	03/05/2021	

Labeler - OXYGEN DEVELOPMENT, LLC (137098492)

Establishment

Name	Address	ID/FEI	Business Operations
OXYGEN DEVELOPMENT, LLC		137098492	manufacture(61354-051)

Revised: 2/2023

OXYGEN DEVELOPMENT, LLC