

# FLOVENT HFA- fluticasone propionate aerosol, metered

## Physicians Total Care, Inc.

-----

### HIGHLIGHTS OF PRESCRIBING INFORMATION

These highlights do not include all the information needed to use FLOVENT HFA safely and effectively. See full prescribing information for FLOVENT HFA.

**FLOVENT HFA 44 mcg (fluticasone propionate 44 mcg) Inhalation Aerosol**

**FLOVENT HFA 110 mcg (fluticasone propionate 110 mcg) Inhalation Aerosol**

**FLOVENT HFA 220 mcg (fluticasone propionate 220 mcg) Inhalation Aerosol**

**FOR ORAL INHALATION ONLY**

**Initial U.S. Approval: 1994**

### INDICATIONS AND USAGE

FLOVENT HFA is an inhaled corticosteroid indicated for: (1)

- Maintenance treatment of asthma as prophylactic therapy in patients aged 4 years and older. (1)
- Treatment of asthma for patients requiring oral corticosteroid therapy. (1)

FLOVENT HFA is NOT indicated for the relief of acute bronchospasm. (1) (1)

### DOSAGE AND ADMINISTRATION

For oral inhalation only. Dosing is based on prior asthma therapy. (2) (2)

Previous Therapy	Recommended Starting Dosage	Highest Recommended Dosage
<b>Patients aged ≥12 years</b>		
Bronchodilators alone	88 mcg twice daily	440 mcg twice daily
Inhaled corticosteroids	88-220 mcg twice daily	440 mcg twice daily
Oral corticosteroids	440 mcg twice daily	880 mcg twice daily
<b>Patients aged 4-11 years</b>	88 mcg twice daily	88 mcg twice daily

### DOSAGE FORMS AND STRENGTHS

Inhalation aerosol with 44, 110, or 220 mcg per actuation. (3) (3)

### CONTRAINDICATIONS

- Primary treatment of status asthmaticus or acute episodes of asthma requiring intensive measures. (4)
- Hypersensitivity to any ingredient. (4)

### WARNINGS AND PRECAUTIONS

- Localized infections: *Candida albicans* infection of the mouth and pharynx. Monitor patients periodically for signs of adverse effects on the oral cavity. Advise patients to rinse mouth following inhalation. (5.1)
- Immunosuppression: Potential worsening of existing tuberculosis; fungal, bacterial, viral, or parasitic infection; or ocular herpes simplex. More serious or even fatal course of chickenpox or measles in susceptible patients. Use caution in patients with above because of the potential for worsening of these infections. (5.3)
- Transferring patients from systemic corticosteroids: Risk of impaired adrenal function when transferring from oral steroids. Taper patients slowly from systemic corticosteroids if transferring to FLOVENT HFA. (5.4)
- Hypercorticism and adrenal suppression: May occur with very high dosages or at the regular dosage in susceptible individuals. If such changes occur, discontinue FLOVENT HFA slowly. (5.5)
- Hypersensitivity reactions, including anaphylaxis, may occur after administration of FLOVENT HFA. Discontinue FLOVENT HFA if such reactions occur. (4, 5.6)
- Decreases in bone mineral density: Assess bone mineral density initially and periodically thereafter in patients at risk. (5.7)
- Effect on growth: Monitor growth of pediatric patients. (5.8)
- Glaucoma and cataracts: Close monitoring is warranted. (5.9)

### ADVERSE REACTIONS

Most common adverse reactions (incidence >3%) include upper respiratory tract infection or inflammation, throat irritation, sinusitis, dysphonia, candidiasis, cough, bronchitis, and headache. (6.1)

**To report SUSPECTED ADVERSE REACTIONS, contact GlaxoSmithKline at 1-888-825-5249 or FDA at 1-800-FDA-1088 or [www.fda.gov/medwatch](http://www.fda.gov/medwatch)**

### DRUG INTERACTIONS

Use with strong cytochrome P450 3A4 inhibitors such as ritonavir and ketoconazole is not recommended. Systemic corticosteroid effects may occur. (7.1) (7)

----- **USE IN SPECIFIC POPULATIONS** -----

Hepatic impairment: Monitor patients for signs of increased drug exposure. (8.6) (8)

**See 17 for PATIENT COUNSELING INFORMATION and FDA-approved patient labeling.**

**Revised: 1/2012**

---

**FULL PRESCRIBING INFORMATION: CONTENTS\***

**1 INDICATIONS AND USAGE**

**2 DOSAGE AND ADMINISTRATION**

**3 DOSAGE FORMS AND STRENGTHS**

**4 CONTRAINDICATIONS**

**5 WARNINGS AND PRECAUTIONS**

5.1 Local Effects

5.2 Acute Asthma Episodes

5.3 Immunosuppression

5.4 Transferring Patients From Systemic Corticosteroid Therapy

5.5 Hypercorticism and Adrenal Suppression

5.6 Hypersensitivity Reactions, Including Anaphylaxis

5.7 Reduction in Bone Mineral Density

5.8 Effect on Growth

5.9 Glaucoma and Cataracts

5.10 Paradoxical Bronchospasm

5.11 Drug Interactions With Strong Cytochrome P450 3A4 Inhibitors

5.12 Eosinophilic Conditions and Churg-Strauss Syndrome

**6 ADVERSE REACTIONS**

6.1 Clinical Trials Experience

6.2 Postmarketing Experience

**7 DRUG INTERACTIONS**

7.1 Strong Cytochrome P450 3A4 Inhibitors

**8 USE IN SPECIFIC POPULATIONS**

8.1 Pregnancy

8.3 Nursing Mothers

8.4 Pediatric Use

8.5 Geriatric Use

8.6 Hepatic Impairment

8.7 Renal Impairment

**10 OVERDOSAGE**

**11 DESCRIPTION**

**12 CLINICAL PHARMACOLOGY**

12.1 Mechanism of Action

12.2 Pharmacodynamics

12.3 Pharmacokinetics

**13 NONCLINICAL TOXICOLOGY**

13.1 Carcinogenesis, Mutagenesis, Impairment of Fertility

13.2 Animal Toxicology and/or Pharmacology

**14 CLINICAL STUDIES**

14.1 Adult and Adolescent Patients Aged 12 Years and Older

14.2 Pediatric Patients Aged 4 to 11 Years

**16 HOW SUPPLIED/STORAGE AND HANDLING**

## 17 PATIENT COUNSELING INFORMATION

- 17.1 Oral Candidiasis
- 17.2 Status Asthmaticus and Acute Asthma Symptoms
- 17.3 Immunosuppression
- 17.4 Hypercorticism and Adrenal Suppression
- 17.5 Hypersensitivity Reactions, Including Anaphylaxis
- 17.6 Reduction in Bone Mineral Density
- 17.7 Reduced Growth Velocity
- 17.8 Ocular Effects
- 17.9 Use Daily for Best Effect

\* Sections or subsections omitted from the full prescribing information are not listed.

---

## FULL PRESCRIBING INFORMATION

### 1 INDICATIONS AND USAGE

FLOVENT<sup>®</sup> HFA Inhalation Aerosol is indicated for the maintenance treatment of asthma as prophylactic therapy in patients aged 4 years and older. It is also indicated for patients requiring oral corticosteroid therapy for asthma. Many of these patients may be able to reduce or eliminate their requirement for oral corticosteroids over time.

FLOVENT HFA Inhalation Aerosol is NOT indicated for the relief of acute bronchospasm.

### 2 DOSAGE AND ADMINISTRATION

FLOVENT HFA should be administered by the orally inhaled route only in patients aged 4 years and older. Individual patients will experience a variable time to onset and degree of symptom relief. Maximum benefit may not be achieved for 1 to 2 weeks or longer after starting treatment.

After asthma stability has been achieved, it is always desirable to titrate to the lowest effective dosage to reduce the possibility of side effects. For patients who do not respond adequately to the starting dosage after 2 weeks of therapy, higher dosages may provide additional asthma control. The safety and efficacy of FLOVENT HFA when administered in excess of recommended dosages have not been established.

The recommended starting dosage and the highest recommended dosage of FLOVENT HFA, based on prior asthma therapy, are listed in Table 1.

**Table 1. Recommended Dosages of FLOVENT HFA Inhalation Aerosol**

**NOTE: In all patients, it is desirable to titrate to the lowest effective dosage once asthma stability is achieved.**

Previous Therapy	Recommended Starting Dosage	Highest Recommended Dosage
<b>Adult and adolescent patients (aged ≥12 years)</b>		
Bronchodilators alone	88 mcg twice daily	
Inhaled corticosteroids	88-220 mcg twice daily <sup>a</sup>	440 mcg twice daily 440 mcg twice daily

Oral corticosteroids <sup>b</sup>	440 mcg twice daily	880 mcg twice daily
<b>Pediatric patients (aged 4-11 years)<sup>c</sup></b>	88 mcg twice daily	88 mcg twice daily

<sup>a</sup> Starting dosages above 88 mcg twice daily may be considered for patients with poorer asthma control or those who have previously required doses of inhaled corticosteroids that are in the higher range for the specific agent.

<sup>b</sup> For patients currently receiving chronic oral corticosteroid therapy, prednisone should be reduced no faster than 2.5 to 5 mg/day on a weekly basis beginning after at least 1 week of therapy with FLOVENT HFA. Patients should be carefully monitored for signs of asthma instability, including serial objective measures of airflow, and for signs of adrenal insufficiency [see *Warnings and Precautions (5.4)*]. Once prednisone reduction is complete, the dosage of FLOVENT HFA should be reduced to the lowest effective dosage.

<sup>c</sup> Recommended pediatric dosage is 88 mcg twice daily regardless of prior therapy. A valved holding chamber and face mask may be used to deliver FLOVENT HFA to young patients.

FLOVENT HFA should be primed before using for the first time by releasing 4 test sprays into the air away from the face, shaking well for 5 seconds before each spray. In cases where the inhaler has not been used for more than 7 days or when it has been dropped, prime the inhaler again by shaking well for 5 seconds and releasing 1 test spray into the air away from the face.

### 3 DOSAGE FORMS AND STRENGTHS

FLOVENT HFA is an inhalation aerosol. Each actuation delivers 44, 110, or 220 mcg of fluticasone propionate from the actuator. FLOVENT HFA 44 mcg is supplied in 10.6-g pressurized aluminum canisters, and FLOVENT HFA 110 mcg and FLOVENT HFA 220 mcg are supplied in 12-g pressurized aluminum canisters. Each canister contains 120 metered inhalations and is fitted with a counter and a dark orange oral actuator with a peach strapcap.

### 4 CONTRAINDICATIONS

The use of FLOVENT HFA is contraindicated in the following conditions:

- Primary treatment of status asthmaticus or other acute episodes of asthma where intensive measures are required [see *Warnings and Precautions (5.2)*]
- Hypersensitivity to any of the ingredients of FLOVENT HFA contraindicates their use [see *Warnings and Precautions (5.6), Adverse Reactions (6.2), Description (11)*]

### 5 WARNINGS AND PRECAUTIONS

#### 5.1 Local Effects

In clinical studies, the development of localized infections of the mouth and pharynx with *Candida albicans* has occurred in patients treated with FLOVENT HFA. When such an infection develops, it should be treated with appropriate local or systemic (i.e., oral antifungal) therapy while treatment with FLOVENT HFA continues, but at times therapy with FLOVENT HFA may need to be interrupted. Patients should rinse the mouth after inhalation of FLOVENT HFA [see *Adverse Reactions (6.1)*].

#### 5.2 Acute Asthma Episodes

FLOVENT HFA is not to be regarded as a bronchodilator and is not indicated for rapid relief of bronchospasm. Patients should be instructed to contact their physicians immediately when episodes of asthma that are not responsive to bronchodilators occur during the course of treatment with FLOVENT HFA. During such episodes, patients may require therapy with oral corticosteroids.

### 5.3 Immunosuppression

Persons who are using drugs that suppress the immune system are more susceptible to infections than healthy individuals. Chickenpox and measles, for example, can have a more serious or even fatal course in susceptible children or adults using corticosteroids. In such children or adults who have not had these diseases or been properly immunized, particular care should be taken to avoid exposure. How the dose, route, and duration of corticosteroid administration affect the risk of developing a disseminated infection is not known. The contribution of the underlying disease and/or prior corticosteroid treatment to the risk is also not known. If a patient is exposed to chickenpox, prophylaxis with varicella zoster immune globulin (VZIG) may be indicated. If a patient is exposed to measles, prophylaxis with pooled intramuscular immunoglobulin (IG) may be indicated. (See the respective package inserts for complete VZIG and IG prescribing information.) If chickenpox develops, treatment with antiviral agents may be considered.

Because of the potential for worsening infections, inhaled corticosteroids should be used with caution, if at all, in patients with active or quiescent tuberculosis infection of the respiratory tract; untreated systemic fungal, bacterial, viral, or parasitic infections; or ocular herpes simplex.

### 5.4 Transferring Patients From Systemic Corticosteroid Therapy

Particular care is needed for patients who have been transferred from systemically active corticosteroids to inhaled corticosteroids because deaths due to adrenal insufficiency have occurred in patients with asthma during and after transfer from systemic corticosteroids to less systemically available inhaled corticosteroids. After withdrawal from systemic corticosteroids, a number of months are required for recovery of hypothalamic-pituitary-adrenal (HPA) function.

Patients requiring oral corticosteroids should be weaned slowly from systemic corticosteroid use after transferring to FLOVENT HFA. In a clinical trial of 168 patients, prednisone reduction was successfully accomplished by reducing the daily prednisone dose on a weekly basis following initiation of treatment with FLOVENT HFA. Successive reduction of prednisone dose was allowed only when lung function, symptoms, and as-needed short-acting beta-agonist use were better than or comparable to that seen before initiation of prednisone dose reduction. Lung function (forced expiratory volume in 1 second [FEV<sub>1</sub>] or morning peak expiratory flow [AM PEF]), beta-agonist use, and asthma symptoms should be carefully monitored during withdrawal of oral corticosteroids. In addition to monitoring asthma signs and symptoms, patients should be observed for signs and symptoms of adrenal insufficiency such as fatigue, lassitude, weakness, nausea and vomiting, and hypotension.

Patients who have been previously maintained on 20 mg or more per day of prednisone (or its equivalent) may be most susceptible, particularly when their systemic corticosteroids have been almost completely withdrawn. During this period of HPA suppression, patients may exhibit signs and symptoms of adrenal insufficiency when exposed to trauma, surgery, or infection (particularly gastroenteritis) or other conditions associated with severe electrolyte loss. Although inhaled corticosteroids may provide control of asthma symptoms during these episodes, in recommended doses they supply less than normal physiological amounts of glucocorticoid (cortisol) systemically and do NOT provide the mineralocorticoid activity that is necessary for coping with these emergencies.

During periods of stress or a severe asthma attack, patients who have been withdrawn from systemic corticosteroids should be instructed to resume oral corticosteroids immediately and to contact their physicians for further instruction. These patients should also be instructed to carry a warning card indicating that they may need supplementary systemic corticosteroids during periods of stress or a severe asthma attack.

Transfer of patients from systemic corticosteroid therapy to FLOVENT HFA may unmask conditions previously suppressed by the systemic corticosteroid therapy (e.g., rhinitis, conjunctivitis, eczema, arthritis, eosinophilic conditions). Some patients may experience symptoms of systemically active corticosteroid withdrawal (e.g., joint and/or muscular pain, lassitude, and depression, despite

maintenance or even improvement of respiratory function).

### **5.5 Hypercorticism and Adrenal Suppression**

Fluticasone propionate will often help control asthma symptoms with less suppression of HPA function than therapeutically equivalent oral doses of prednisone. Since fluticasone propionate is absorbed into the circulation and can be systemically active at higher doses, the beneficial effects of FLOVENT HFA in minimizing HPA dysfunction may be expected only when recommended dosages are not exceeded and individual patients are titrated to the lowest effective dose. A relationship between plasma levels of fluticasone propionate and inhibitory effects on stimulated cortisol production has been shown after 4 weeks of treatment with fluticasone propionate. Since individual sensitivity to effects on cortisol production exists, physicians should consider this information when prescribing FLOVENT HFA.

Because of the possibility of systemic absorption of inhaled corticosteroids, patients treated with FLOVENT HFA should be observed carefully for any evidence of systemic corticosteroid effects. Particular care should be taken in observing patients postoperatively or during periods of stress for evidence of inadequate adrenal response.

It is possible that systemic corticosteroid effects such as hypercorticism and adrenal suppression (including adrenal crisis) may appear in a small number of patients, particularly when FLOVENT HFA is administered at higher than recommended doses over prolonged periods of time. If such effects occur, the dosage of FLOVENT HFA should be reduced slowly, consistent with accepted procedures for reducing systemic corticosteroids and for management of asthma.

### **5.6 Hypersensitivity Reactions, Including Anaphylaxis**

Hypersensitivity reactions, including anaphylaxis, angioedema, urticaria, and bronchospasm, may occur after administration of FLOVENT HFA [see *Contraindications (4)*].

### **5.7 Reduction in Bone Mineral Density**

Decreases in bone mineral density (BMD) have been observed with long-term administration of products containing inhaled corticosteroids. The clinical significance of small changes in BMD with regard to long-term outcomes is unknown. Patients with major risk factors for decreased bone mineral content, such as prolonged immobilization, family history of osteoporosis, postmenopausal status, tobacco use, advanced age, poor nutrition, or chronic use of drugs that can reduce bone mass (e.g., anticonvulsants, oral corticosteroids), should be monitored and treated with established standards of care.

### **5.8 Effect on Growth**

Orally inhaled corticosteroids may cause a reduction in growth velocity when administered to pediatric patients [see *Use in Specific Populations (8.4)*]. Monitor the growth of pediatric patients receiving FLOVENT HFA routinely (e.g., via stadiometry). To minimize the systemic effects of orally inhaled corticosteroids, including FLOVENT HFA, titrate each patient's dosage to the lowest dosage that effectively controls his/her symptoms [see *Dosage and Administration (2)*].

### **5.9 Glaucoma and Cataracts**

Glaucoma, increased intraocular pressure, and cataracts have been reported in patients following the long-term administration of inhaled corticosteroids, including fluticasone propionate. Therefore, close monitoring is warranted in patients with a change in vision or with a history of increased intraocular pressure, glaucoma, and/or cataracts.

### **5.10 Paradoxical Bronchospasm**

As with other inhaled medications, bronchospasm may occur with an immediate increase in wheezing after dosing. If bronchospasm occurs following dosing with FLOVENT HFA, it should be treated

immediately with a fast-acting inhaled bronchodilator. Treatment with FLOVENT HFA should be discontinued immediately and alternative therapy instituted.

### 5.11 Drug Interactions With Strong Cytochrome P450 3A4 Inhibitors

The use of strong cytochrome P450 3A4 (CYP3A4) inhibitors (e.g., ritonavir, atazanavir, clarithromycin, indinavir, itraconazole, nefazodone, nelfinavir, saquinavir, ketoconazole, telithromycin) with FLOVENT HFA is not recommended because increased systemic corticosteroid adverse effects may occur [see Drug Interactions (7.1), Clinical Pharmacology (12.3)].

### 5.12 Eosinophilic Conditions and Churg-Strauss Syndrome

In rare cases, patients on inhaled fluticasone propionate may present with systemic eosinophilic conditions. Some of these patients have clinical features of vasculitis consistent with Churg-Strauss syndrome, a condition that is often treated with systemic corticosteroid therapy. These events usually, but not always, have been associated with the reduction and/or withdrawal of oral corticosteroid therapy following the introduction of fluticasone propionate. Cases of serious eosinophilic conditions have also been reported with other inhaled corticosteroids in this clinical setting. Physicians should be alert to eosinophilia, vasculitic rash, worsening pulmonary symptoms, cardiac complications, and/or neuropathy presenting in their patients. A causal relationship between fluticasone propionate and these underlying conditions has not been established.

## 6 ADVERSE REACTIONS

Systemic and local corticosteroid use may result in the following:

- *Candida albicans* infection [see Warnings and Precautions (5.1)]
- Immunosuppression [see Warnings and Precautions (5.3)]
- Hypercorticism and adrenal suppression [see Warnings and Precautions (5.5)]
- Reduction in bone mineral density [see Warnings and Precautions (5.7)]
- Growth effects [see Warnings and Precautions (5.8)]
- Glaucoma and cataracts [see Warnings and Precautions (5.9)]

### 6.1 Clinical Trials Experience

Because clinical trials are conducted under widely varying conditions, adverse reaction rates observed in the clinical trials of a drug cannot be directly compared with rates in the clinical trials of another drug and may not reflect the rates observed in practice.

The incidence of common adverse reactions in Table 2 is based upon 2 placebo-controlled US clinical trials in which 812 adult and adolescent patients (457 females and 355 males) previously treated with as-needed bronchodilators and/or inhaled corticosteroids were treated twice daily for up to 12 weeks with 2 inhalations of FLOVENT HFA 44 mcg Inhalation Aerosol, FLOVENT HFA 110 mcg Inhalation Aerosol, FLOVENT HFA 220 mcg Inhalation Aerosol (dosages of 88, 220, or 440 mcg twice daily), or placebo.

**Table 2. Adverse Reactions With >3% Incidence in US Controlled Clinical Trials With FLOVENT HFA in Patients Aged 12 Years and Older With Asthma Previously Receiving Bronchodilators and/or Inhaled Corticosteroids**

	FLOVENT HFA 88 mcg Twice Daily	FLOVENT HFA 220 mcg Twice Daily	FLOVENT HFA 440 mcg Twice Daily	Placebo

Adverse Event	(n = 203) %	(n = 204) %	(n = 202) %	(n = 203) %
Ear, nose, and throat				
Upper respiratory tract infection	18	16	16	14
Throat irritation	8	8	10	5
Upper respiratory inflammation	2	5	5	1
Sinusitis/sinus infection	6	7	4	3
Hoarseness/dysphonia	2	3	6	<1
Gastrointestinal				
Candidiasis mouth/throat & non-site specific	4	2	5	<1
Lower respiratory				
Cough	4	6	4	5
Bronchitis	2	2	6	5
Neurological				
Headache	11	7	5	6

Table 2 includes all events (whether considered drug-related or nondrug-related by the investigator) that occurred at a rate of over 3% in any of the groups treated with FLOVENT HFA and were more common than in the placebo group. Less than 2% of patients discontinued from the studies because of adverse reactions. The average duration of exposure was 73 to 76 days in the active treatment groups compared with 60 days in the placebo group.

**Additional Adverse Reactions:** Other adverse reactions not previously listed, whether considered drug-related or not by the investigators, that were reported more frequently by patients with asthma treated with FLOVENT HFA compared with patients treated with placebo include the following: rhinitis, rhinorrhea/post-nasal drip, nasal sinus disorders, laryngitis, diarrhea, viral gastrointestinal infections, dyspeptic symptoms, gastrointestinal discomfort and pain, hyposalivation, musculoskeletal pain, muscle pain, muscle stiffness/tightness/rigidity, dizziness, migraines, fever, viral infections, pain, chest symptoms, viral skin infections, muscle injuries, soft tissue injuries, urinary infections.

Fluticasone propionate inhalation aerosol (440 or 880 mcg twice daily) was administered for 16 weeks to 168 patients with asthma requiring oral corticosteroids (Study 3). Adverse reactions not included above, but reported by more than 3 patients in either group treated with FLOVENT HFA and more commonly than in the placebo group included nausea and vomiting, arthralgia and articular rheumatism, and malaise and fatigue.

In 2 long-term studies (26 and 52 weeks), the pattern of adverse reactions in patients treated with FLOVENT HFA at dosages up to 440 mcg twice daily was similar to that observed in the 12-week studies. There were no new and/or unexpected adverse reactions with long-term treatment.

**Pediatric Patients Aged 4 to 11 Years:** FLOVENT HFA has been evaluated for safety in 56 pediatric patients who received 88 mcg twice daily for 4 weeks. Types of adverse reactions in these pediatric patients were generally similar to those observed in adults and adolescents.

## 6.2 Postmarketing Experience

In addition to adverse reactions reported from clinical trials, the following adverse reactions have been identified during postmarketing use of fluticasone propionate. Because these reactions are reported voluntarily from a population of uncertain size, it is not always possible to reliably estimate their



frequency or establish a causal relationship to drug exposure. These events have been chosen for inclusion due to either their seriousness, frequency of reporting, or causal connection to fluticasone propionate or a combination of these factors.

Ear, Nose, and Throat: Aphonia, facial and oropharyngeal edema, and throat soreness and irritation.

Endocrine and Metabolic: Cushingoid features, growth velocity reduction in children/adolescents, hyperglycemia, osteoporosis, and weight gain.

Eye: Cataracts.

Gastrointestinal Disorders: Dental caries and tooth discoloration.

Psychiatry: Agitation, aggression, anxiety, depression, and restlessness. Behavioral changes, including hyperactivity and irritability, have been reported very rarely and primarily in children.

Immune System Disorders: Immediate and delayed hypersensitivity reactions, including urticaria, anaphylaxis, rash, and angioedema and bronchospasm, have been reported.

Respiratory: Asthma exacerbation, chest tightness, cough, dyspnea, immediate and delayed bronchospasm, paradoxical bronchospasm, pneumonia, and wheeze.

Skin: Contusions, cutaneous hypersensitivity reactions, ecchymoses, and pruritus.

Eosinophilic Conditions: In rare cases, patients on inhaled fluticasone propionate may present with systemic eosinophilic conditions, with some patients presenting with clinical features of vasculitis consistent with Churg-Strauss syndrome, a condition that is often treated with systemic corticosteroid therapy. These events usually, but not always, have been associated with the reduction and/or withdrawal of oral corticosteroid therapy following the introduction of fluticasone propionate [see *Warnings and Precautions (5.12)*].

## **7 DRUG INTERACTIONS**

### **7.1 Strong Cytochrome P450 3A4 Inhibitors**

Fluticasone propionate is a substrate of CYP3A4. The use of strong CYP3A4 inhibitors (e.g., ritonavir, atazanavir, clarithromycin, indinavir, itraconazole, nefazodone, nelfinavir, saquinavir, ketoconazole, telithromycin) with FLOVENT HFA is not recommended because increased systemic corticosteroid adverse effects may occur.

A drug interaction study with fluticasone propionate aqueous nasal spray in healthy subjects has shown that ritonavir (a strong CYP3A4 inhibitor) can significantly increase plasma fluticasone propionate concentration, resulting in significantly reduced serum cortisol concentrations [see *Clinical Pharmacology (12.3)*]. During postmarketing use, there have been reports of clinically significant drug interactions in patients receiving fluticasone propionate and ritonavir, resulting in systemic corticosteroid effects including Cushing's syndrome and adrenal suppression. Therefore, coadministration of fluticasone propionate and ritonavir is not recommended unless the potential benefit to the patient outweighs the risk of systemic corticosteroid side effects.

Coadministration of orally inhaled fluticasone propionate (1,000 mcg) and ketoconazole (200 mg once daily) resulted in a 1.9-fold increase in plasma fluticasone propionate exposure and a 45% decrease in plasma cortisol area under the curve (AUC), but had no effect on urinary excretion of cortisol. Coadministration of fluticasone propionate and ketoconazole is not recommended unless the potential benefit to the patient outweighs the risk of systemic corticosteroid side effects.

## **8 USE IN SPECIFIC POPULATIONS**

### **8.1 Pregnancy**

Pregnancy Category C. There are no adequate and well-controlled studies with FLOVENT HFA in pregnant women. FLOVENT HFA should be used during pregnancy only if the potential benefit justifies the potential risk to the fetus.

**Teratogenic Effects:** Subcutaneous studies in mice at a dose approximately 0.1 times the maximum recommended human daily inhalation dose (MRHD) in adults on a mg/m<sup>2</sup> basis and in the rat at a dose approximately 0.5 times the MRHD in adults on a mg/m<sup>2</sup> basis revealed fetal toxicity characteristic of potent corticosteroid compounds, including embryonic growth retardation, omphalocele, cleft palate, and retarded cranial ossification.

In rabbits, fetal weight reduction and cleft palate were observed at a subcutaneous dose approximately 0.04 times the MRHD in adults on a mg/m<sup>2</sup> basis. However, no teratogenic effects were reported at oral doses up to approximately 3 times the MRHD in adults on a mg/m<sup>2</sup> basis. No fluticasone propionate was detected in the plasma in this study, consistent with the established low bioavailability following oral administration [see *Clinical Pharmacology (12.3)*].

Experience with oral corticosteroids since their introduction in pharmacologic, as opposed to physiologic, doses suggests that rodents are more prone to teratogenic effects from corticosteroids than humans. In addition, because there is a natural increase in corticosteroid production during pregnancy, most women will require a lower exogenous corticosteroid dose and many will not need corticosteroid treatment during pregnancy.

### 8.3 Nursing Mothers

It is not known whether fluticasone propionate is excreted in human breast milk. However, other corticosteroids have been detected in human milk. Subcutaneous administration to lactating rats of tritiated fluticasone propionate (approximately 0.05 times the MRHD in adults on a mg/m<sup>2</sup> basis) resulted in measurable radioactivity in milk.

Since there are no data from controlled trials on the use of FLOVENT HFA by nursing mothers, caution should be exercised when FLOVENT HFA is administered to a nursing woman.

### 8.4 Pediatric Use

The safety and effectiveness of FLOVENT HFA in children 4 years and older have been established [see *Adverse Reactions (6.1)*, *Clinical Pharmacology (12.3)*, *Clinical Studies (14.2)*]. The safety and effectiveness of FLOVENT HFA in children younger than 4 years have not been established. Use of FLOVENT HFA in patients aged 4 to 11 years is supported by evidence from adequate and well-controlled studies in adults and adolescents 12 years and older, pharmacokinetic studies in patients aged 4 to 11 years, established efficacy of fluticasone propionate formulated as FLOVENT<sup>®</sup> DISKUS<sup>®</sup> (fluticasone propionate inhalation powder) and FLOVENT<sup>®</sup> ROTADISK<sup>®</sup> (fluticasone propionate inhalation powder) in patients aged 4 to 11 years, and supportive findings with FLOVENT HFA in a study conducted in patients aged 4 to 11 years.

**Effects on Growth:** Orally inhaled corticosteroids may cause a reduction in growth velocity when administered to pediatric patients. A reduction of growth velocity in children or teenagers may occur as a result of poorly controlled asthma or from use of corticosteroids including inhaled corticosteroids. The effects of long-term treatment of children and adolescents with inhaled corticosteroids, including fluticasone propionate, on final adult height are not known.

Controlled clinical studies have shown that inhaled corticosteroids may cause a reduction in growth in pediatric patients. In these studies, the mean reduction in growth velocity was approximately 1 cm/year (range: 0.3 to 1.8 cm/year) and appears to depend upon dose and duration of exposure. This effect was observed in the absence of laboratory evidence of HPA axis suppression, suggesting that growth velocity is a more sensitive indicator of systemic corticosteroid exposure in pediatric patients than some commonly used tests of HPA axis function. The long-term effects of this reduction in growth velocity associated with orally inhaled corticosteroids, including the impact on final adult height, are unknown. The potential for “catch-up” growth following discontinuation of treatment with orally inhaled

corticosteroids has not been adequately studied. The effects on growth velocity of treatment with orally inhaled corticosteroids for over 1 year, including the impact on final adult height, are unknown. The growth of children and adolescents receiving orally inhaled corticosteroids, including FLOVENT HFA, should be monitored routinely (e.g., via stadiometry). The potential growth effects of prolonged treatment should be weighed against the clinical benefits obtained and the risks associated with alternative therapies. To minimize the systemic effects of orally inhaled corticosteroids, including FLOVENT HFA, each patient should be titrated to the lowest dose that effectively controls his/her symptoms.

Since a cross study comparison in adolescent and adult patients (aged 12 years and older) indicated that systemic exposure of inhaled fluticasone propionate from FLOVENT HFA would be higher than exposure from FLOVENT ROTADISK, results from a study to assess the potential growth effects of FLOVENT ROTADISK in pediatric patients (aged 4 to 11 years) are provided.

A 52-week placebo-controlled study to assess the potential growth effects of fluticasone propionate inhalation powder (FLOVENT ROTADISK) at 50 and 100 mcg twice daily was conducted in the US in 325 prepubescent children (244 males and 81 females) aged 4 to 11 years. The mean growth velocities at 52 weeks observed in the intent-to-treat population were 6.32 cm/year in the placebo group (n = 76), 6.07 cm/year in the 50-mcg group (n = 98), and 5.66 cm/year in the 100-mcg group (n = 89). An imbalance in the proportion of children entering puberty between groups and a higher dropout rate in the placebo group due to poorly controlled asthma may be confounding factors in interpreting these data. A separate subset analysis of children who remained prepubertal during the study revealed growth rates at 52 weeks of 6.10 cm/year in the placebo group (n = 57), 5.91 cm/year in the 50-mcg group (n = 74), and 5.67 cm/year in the 100-mcg group (n = 79). In children aged 8.5 years, the mean age of children in this study, the range for expected growth velocity is: boys – 3rd percentile = 3.8 cm/year, 50th percentile = 5.4 cm/year, and 97th percentile = 7.0 cm/year; girls – 3rd percentile = 4.2 cm/year, 50th percentile = 5.7 cm/year, and 97th percentile = 7.3 cm/year.

The clinical significance of these growth data is not certain. Physicians should closely follow the growth of children and adolescents taking corticosteroids by any route, and weigh the benefits of corticosteroid therapy against the possibility of growth suppression if growth appears slowed. Patients should be maintained on the lowest dose of inhaled corticosteroid that effectively controls their asthma.

Children Younger Than 4 Years: Pharmacokinetics: [see Clinical Pharmacology (12.3)].

*Pharmacodynamics:* A 12-week, double-blind, placebo-controlled, parallel-group study was conducted in children with asthma aged 1 to less than 4 years. Twelve-hour overnight urinary cortisol excretion after a 12-week treatment period with 88 mcg of FLOVENT HFA twice daily (n = 73) and with placebo (n = 42) were calculated. The mean and median change from baseline in urine cortisol over 12 hours were -0.7 and 0.0 mcg for FLOVENT HFA and 0.3 and -0.2 mcg for placebo, respectively.

In a 1-way crossover study in children aged 6 to less than 12 months with reactive airways disease (N = 21), serum cortisol was measured over a 12-hour dosing period. Patients received placebo treatment for a 2-week period followed by a 4-week treatment period with 88 mcg of FLOVENT HFA twice daily with an AeroChamber Plus® Valved Holding Chamber (VHC) with face mask. The geometric mean ratio of serum cortisol over 12 hours (AUC<sub>0-12 hr</sub>) following FLOVENT HFA (n = 16) versus placebo (n = 18) was 0.95 (95% CI: 0.72, 1.27).

*Safety:* FLOVENT HFA administered as 88 mcg twice daily has been evaluated for safety in 239 pediatric patients aged 1 to less than 4 years in a 12-week, double-blind, placebo-controlled study. Treatments were administered with an AeroChamber Plus VHC with face mask. In pediatric patients aged 1 to less than 4 years receiving FLOVENT HFA, the following events occurred with a frequency greater than 3% and more frequently than in pediatric patients who received placebo, regardless of causality assessment: pyrexia, nasopharyngitis, upper respiratory tract infection, vomiting, otitis media, diarrhea, bronchitis, pharyngitis, and viral infection.

FLOVENT HFA administered as 88 mcg twice daily has also been evaluated for safety in 23 pediatric

patients aged 6 to 12 months in an open-label placebo-controlled study. Treatments were administered with an AeroChamber Plus VHC with face mask for 2 weeks with placebo followed by 4 weeks with active drug. There was no discernable difference in the types of adverse events reported between patients receiving placebo compared to the active drug.

*In Vitro Testing of Dose Delivery With Holding Chambers:* In vitro dose characterization studies were performed to evaluate the delivery of FLOVENT HFA via holding chambers with attached face masks. The studies were conducted with 2 different holding chambers (AeroChamber Plus VHC and AeroChamber Z-STAT Plus™ VHC) and face masks (small and medium size) at inspiratory flow rates of 4.9, 8.0, and 12.0 L/min in combination with holding times of 0, 2, 5, and 10 seconds. The flow rates were selected to be representative of inspiratory flow rates of children aged 6 to 12 months, 2 to 5 years, and over 5 years, respectively. The mean delivered dose of fluticasone propionate through the holding chambers with face masks was lower than the 44 mcg of fluticasone propionate delivered directly from the actuator mouthpiece. The results were similar through both holding chambers (see Table 3 for data for the AeroChamber Plus VHC). The fine particle fraction (approximately 1 to 5 µm) across the flow rates used in these studies was 70% to 84% of the delivered dose, consistent with the removal of the coarser fraction by the holding chamber. In contrast, the fine particle fraction for FLOVENT HFA delivered without a holding chamber typically represents 42% to 55% of the delivered dose measured at the standard flow rate of 28.3 L/min. These data suggest that, on a per kilogram basis, young children receive a comparable dose of fluticasone propionate when delivered via a holding chamber and face mask as adults do without their use.

**Table 3. In Vitro Medication Delivery Through AeroChamber Plus Valved Holding Chamber With a Face Mask**

Age	Face Mask	Flow Rate (L/min)	Holding Time (seconds)	Mean Medication Delivery Through AeroChamber Plus VHC (mcg/actuation)	Body Weight 50 <sup>th</sup> Percentile (kg) <sup>a</sup>	Medication Delivered per Actuation (mcg/kg) <sup>b</sup>
6 to 12 Months	Small	4.9	0	8.3	7.5-9.9	0.8-1.1
			2	6.7		0.7-0.9
			5	7.5		0.8-1.0
			10	7.5		0.8-1.0
2 to 5 Years	Small	8.0	0	7.3	12.3-18.0	0.4-0.6
			2	6.8		0.4-0.6
			5	6.7		0.4-0.5
			10	7.7		0.4-0.6
2 to 5 Years	Medium	8.0	0	7.8	12.3-18.0	0.4-0.6
			2	7.7		0.4-0.6
			5	8.1		0.5-0.7
			10	9.0		0.5-0.7
>5 Years	Medium	12.0	0	12.3	18.0	0.7
			2	11.8		0.7
			5	12.0		0.7
			10	10.1		0.6

<sup>a</sup> Centers for Disease Control growth charts, developed by the National Center for Health Statistics in collaboration with the National Center for Chronic Disease Prevention and Health Promotion (2000). Ranges correspond to the average of the 50<sup>th</sup> percentile weight for boys and girls at the ages indicated.

<sup>b</sup> A single inhalation of FLOVENT HFA in a 70-kg adult without use of a valved holding chamber and face mask delivers approximately 44 mcg, or 0.6 mcg/kg.

## 8.5 Geriatric Use

Of the total number of patients treated with FLOVENT HFA in US and non-US clinical trials, 173 were 65 years or older, 19 of which were 75 years or older. No overall differences in safety or effectiveness were observed between these patients and younger patients, and other reported clinical experience has not identified differences in responses between the elderly and younger patients, but greater sensitivity of some older individuals cannot be ruled out.

## 8.6 Hepatic Impairment

Formal pharmacokinetic studies using FLOVENT HFA have not been conducted in patients with hepatic impairment. Since fluticasone propionate is predominantly cleared by hepatic metabolism, impairment of liver function may lead to accumulation of fluticasone propionate in plasma. Therefore, patients with hepatic disease should be closely monitored.

## 8.7 Renal Impairment

Formal pharmacokinetic studies using FLOVENT HFA have not been conducted in patients with renal impairment.

## 10 OVERDOSAGE

Chronic overdosage may result in signs/symptoms of hypercorticism [see *Warnings and Precautions* (5.5)]. Inhalation by healthy volunteers of a single dose of 1,760 or 3,520 mcg of fluticasone propionate CFC inhalation aerosol was well tolerated. Doses of 1,320 mcg administered to healthy human volunteers twice daily for 7 to 15 days were also well tolerated. Repeat oral doses up to 80 mg daily for 10 days in healthy volunteers and repeat oral doses up to 20 mg daily for 42 days in patients were well tolerated. Adverse reactions were of mild or moderate severity, and incidences were similar in active and placebo treatment groups.

No deaths were seen in mice given an oral dose of 1,000 mg/kg (approximately 2,300 and 11,000 times the MRHD for adults and children aged 4 to 11 years, respectively, on a mg/m<sup>2</sup> basis). No deaths were seen in rats given an oral dose of 1,000 mg/kg (approximately 4,600 and 22,000 times the MRHD in adults and children aged 4 to 11 years, respectively, on a mg/m<sup>2</sup> basis).

## 11 DESCRIPTION

The active component of FLOVENT HFA 44 mcg Inhalation Aerosol, FLOVENT HFA 110 mcg Inhalation Aerosol, and FLOVENT HFA 220 mcg Inhalation Aerosol is fluticasone propionate, a corticosteroid having the chemical name *S*-(fluoromethyl) 6 $\alpha$ ,9-difluoro-11 $\beta$ ,17-dihydroxy-16 $\alpha$ -methyl-3-oxoandrost-1,4-diene-17 $\beta$ -carbothioate, 17-propionate and the following chemical structure:

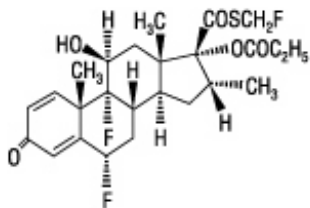

Fluticasone propionate is a white powder with a molecular weight of 500.6, and the empirical formula is C<sub>25</sub>H<sub>31</sub>F<sub>3</sub>O<sub>5</sub>S. It is practically insoluble in water, freely soluble in dimethyl sulfoxide and

dimethylformamide, and slightly soluble in methanol and 95% ethanol.

FLOVENT HFA 44 mcg Inhalation Aerosol, FLOVENT HFA 110 mcg Inhalation Aerosol, and FLOVENT HFA 220 mcg Inhalation Aerosol are pressurized metered-dose aerosol units fitted with a counter. FLOVENT HFA is intended for oral inhalation only. Each unit contains a microcrystalline suspension of fluticasone propionate (micronized) in propellant HFA-134a (1,1,1,2-tetrafluoroethane). It contains no other excipients.

After priming, each actuation of the inhaler delivers 50, 125, or 250 mcg of fluticasone propionate in 60 mg of suspension (for the 44-mcg product) or in 75 mg of suspension (for the 110- and 220-mcg products) from the valve. Each actuation delivers 44, 110, or 220 mcg of fluticasone propionate from the actuator. The actual amount of drug delivered to the lung may depend on patient factors, such as the coordination between the actuation of the device and inspiration through the delivery system.

Each 10.6-g canister (44 mcg) and each 12-g canister (110 and 220 mcg) provides 120 inhalations.

FLOVENT HFA should be primed before using for the first time by releasing 4 test sprays into the air away from the face, shaking well for 5 seconds before each spray. In cases where the inhaler has not been used for more than 7 days or when it has been dropped, prime the inhaler again by shaking well for 5 seconds and releasing 1 test spray into the air away from the face.

This product does not contain any chlorofluorocarbon (CFC) as the propellant.

## **12 CLINICAL PHARMACOLOGY**

### **12.1 Mechanism of Action**

Fluticasone propionate is a synthetic trifluorinated corticosteroid with potent anti-inflammatory activity. In vitro assays using human lung cytosol preparations have established fluticasone propionate as a human glucocorticoid receptor agonist with an affinity 18 times greater than dexamethasone, almost twice that of beclomethasone 17-monopropionate (BMP), the active metabolite of beclomethasone dipropionate, and over 3 times that of budesonide. Data from the McKenzie vasoconstrictor assay in man are consistent with these results. The clinical significance of these findings is unknown.

Inflammation is an important component in the pathogenesis of asthma. Corticosteroids have been shown to inhibit multiple cell types (e.g., mast cells, eosinophils, basophils, lymphocytes, macrophages, neutrophils) and mediator production or secretion (e.g., histamine, eicosanoids, leukotrienes, cytokines) involved in the asthmatic response. These anti-inflammatory actions of corticosteroids contribute to their efficacy in asthma.

Though effective for the treatment of asthma, corticosteroids do not affect asthma symptoms immediately. Individual patients will experience a variable time to onset and degree of symptom relief. Maximum benefit may not be achieved for 1 to 2 weeks or longer after starting treatment. When corticosteroids are discontinued, asthma stability may persist for several days or longer.

Studies in patients with asthma have shown a favorable ratio between topical anti-inflammatory activity and systemic corticosteroid effects with recommended doses of orally inhaled fluticasone propionate. This is explained by a combination of a relatively high local anti-inflammatory effect, negligible oral systemic bioavailability (less than 1%), and the minimal pharmacological activity of the only metabolite detected in man.

### **12.2 Pharmacodynamics**

Serum cortisol concentrations, urinary excretion of cortisol, and urine 6- $\beta$ -hydroxycortisol excretion collected over 24 hours in 24 healthy subjects following 8 inhalations of fluticasone propionate HFA 44, 110, and 220 mcg decreased with increasing dose. However, in patients with asthma treated with 2 inhalations of fluticasone propionate HFA 44, 110, and 220 mcg twice daily for at least 4 weeks, differences in serum cortisol AUC<sub>(0-12 hr)</sub> (n = 65) and 24-hour urinary excretion of cortisol (n = 47)

compared with placebo were not related to dose and generally not significant. In the study with healthy volunteers, the effect of propellant was also evaluated by comparing results following the 220-mcg strength inhaler containing HFA 134a propellant with the same strength of inhaler containing CFC 11/12 propellant. A lesser effect on the HPA axis with the HFA formulation was observed for serum cortisol, but not urine cortisol and 6-betahydroxy cortisol excretion. In addition, in a crossover study of children with asthma aged 4 to 11 years (N = 40), 24-hour urinary excretion of cortisol was not affected after a 4-week treatment period with 88 mcg of fluticasone propionate HFA twice daily compared with urinary excretion after the 2-week placebo period. The ratio (95% CI) of urinary excretion of cortisol over 24 hours following fluticasone propionate HFA versus placebo was 0.987 (0.796, 1.223).

The potential systemic effects of fluticasone propionate HFA on the HPA axis were also studied in patients with asthma. Fluticasone propionate given by inhalation aerosol at dosages of 440 or 880 mcg twice daily was compared with placebo in oral corticosteroid-dependent patients with asthma (range of mean dose of prednisone at baseline: 13 to 14 mg/day) in a 16-week study. Consistent with maintenance treatment with oral corticosteroids, abnormal plasma cortisol responses to short cosyntropin stimulation (peak plasma cortisol less than 18 mcg/dL) were present at baseline in the majority of patients participating in this study (69% of patients later randomized to placebo and 72% to 78% of patients later randomized to fluticasone propionate HFA). At week 16, 8 patients (73%) on placebo compared with 14 (54%) and 13 (68%) patients receiving fluticasone propionate HFA (440 and 880 mcg twice daily, respectively) had post-stimulation cortisol levels of less than 18 mcg/dL.

### 12.3 Pharmacokinetics

**Absorption:** Fluticasone propionate acts locally in the lung; therefore, plasma levels do not predict therapeutic effect. Studies using oral dosing of labeled and unlabeled drug have demonstrated that the oral systemic bioavailability of fluticasone propionate is negligible (less than 1%), primarily due to incomplete absorption and presystemic metabolism in the gut and liver. In contrast, the majority of the fluticasone propionate delivered to the lung is systemically absorbed.

**Distribution:** Following intravenous administration, the initial disposition phase for fluticasone propionate was rapid and consistent with its high lipid solubility and tissue binding. The volume of distribution averaged 4.2 L/kg.

The percentage of fluticasone propionate bound to human plasma proteins averages 99%. Fluticasone propionate is weakly and reversibly bound to erythrocytes and is not significantly bound to human transcortin.

**Metabolism:** The total clearance of fluticasone propionate is high (average, 1,093 mL/min), with renal clearance accounting for less than 0.02% of the total. The only circulating metabolite detected in man is the 17 $\beta$ -carboxylic acid derivative of fluticasone propionate, which is formed through the CYP 3A4 pathway. This metabolite had less affinity (approximately 1/2,000) than the parent drug for the corticosteroid receptor of human lung cytosol in vitro and negligible pharmacological activity in animal studies. Other metabolites detected in vitro using cultured human hepatoma cells have not been detected in man.

**Elimination:** Following intravenous dosing, fluticasone propionate showed polyexponential kinetics and had a terminal elimination half-life of approximately 7.8 hours. Less than 5% of a radiolabeled oral dose was excreted in the urine as metabolites, with the remainder excreted in the feces as parent drug and metabolites.

**Specific Populations: Gender:** No significant difference in clearance (CL/F) of fluticasone propionate was observed.

**Pediatrics:** A population pharmacokinetic analysis was performed for FLOVENT HFA using steady-state data from 4 controlled clinical trials and single-dose data from 1 controlled clinical trial. The combined cohort for analysis included 269 patients (161 males and 108 females) with asthma aged 6 months to 66 years who received treatment with FLOVENT HFA. Most of these subjects (n = 215)

were treated with FLOVENT HFA 44 mcg given as 88 mcg twice daily. FLOVENT HFA was delivered using an AeroChamber Plus VHC with a face mask to patients aged less than 4 years. Data from adult patients with asthma following FLOVENT HFA 110 mcg given as 220 mcg twice daily (n = 15) and following FLOVENT HFA 220 mcg given as 440 mcg twice daily (n = 17) at steady state were also included. Data for 22 patients came from a single-dose crossover study of 264 mcg (6 doses of FLOVENT HFA 44 mcg) with and without AeroChamber Plus VHC in children with asthma aged 4 to 11 years.

Stratification of exposure data following FLOVENT HFA 88 mcg by age and study indicated that systemic exposure to fluticasone propionate at steady state was similar in children aged 6 to less than 12 months, children aged 1 to less than 4 years, and adults and adolescents aged 12 years and older. Exposure was lower in children aged 4 to 11 years, who did not use a VHC, as shown in Table 4.

**Table 4. Systemic Exposure to Fluticasone Propionate Following FLOVENT HFA 88 mcg Twice Daily**

Age	Valved Holding Chamber	N	AUC <sub>0-τ</sub> , pg•hr/mL (95% CI)	C <sub>max</sub> , pg/mL (95% CI)
6 to <12 Months	Yes	17	141 (88, 227)	19 (13, 29)
1 to <4 Years	Yes	164	143 (131, 157)	20 (18, 21)
4 to 11 Years	No	14	68 (48, 97)	11 (8, 16)
≥12 Years	No	20	149 (106, 210)	20 (15, 27)

The lower exposure to fluticasone propionate in children aged 4 to 11 years who did not use a VHC may reflect the inability to coordinate actuation and inhalation of the metered-dose inhaler. The impact of the use of a VHC on exposure to fluticasone propionate in patients aged 4 to 11 years was evaluated in a single-dose crossover study with FLOVENT HFA 44 mcg given as 264 mcg. In this study, use of a VHC increased systemic exposure to fluticasone propionate (Table 5), possibly correcting for the inability to coordinate actuation and inhalation.

**Table 5. Systemic Exposure to Fluticasone Propionate Following a Single Dose of FLOVENT HFA 264 mcg**

Age	Valved Holding Chamber	N	AUC <sub>(0-∞)</sub> , pg•hr/mL (95% CI)	C <sub>max</sub> , pg/mL (95% CI)
4 to 11 Years	Yes	22	373 (297, 468)	61 (51, 73)
4 to 11 Years	No	21	141 (111, 178)	23 (19, 28)

There was a dose-related increase in systemic exposure in patients aged 12 years and older receiving higher doses of fluticasone propionate (220 and 440 mcg twice daily). The AUC<sub>0-τ</sub> in pg•hr/mL was 358 (95% CI: 272, 473) and 640 (95% CI: 477, 858), and C<sub>max</sub> in pg/mL was 47.3 (95% CI: 37, 61) and 87 (95% CI: 68, 112) following fluticasone propionate 220 and 440 mcg, respectively.

*Hepatic and Renal Impairment:* Formal pharmacokinetic studies using FLOVENT HFA have not been conducted in patients with hepatic or renal impairment. However, since fluticasone propionate is predominantly cleared by hepatic metabolism, impairment of liver function may lead to accumulation of



fluticasone propionate in plasma. Therefore, patients with hepatic disease should be closely monitored.

*Race:* No significant difference in clearance (CL/F) of fluticasone propionate in Caucasian, African-American, Asian, or Hispanic populations was observed.

*Drug Interactions:Ritonavir:* Fluticasone propionate is a substrate of CYP3A4. Coadministration of fluticasone propionate and the strong CYP3A4 inhibitor ritonavir is not recommended based upon a multiple-dose, crossover drug interaction study in 18 healthy subjects. Fluticasone propionate aqueous nasal spray (200 mcg once daily) was coadministered for 7 days with ritonavir (100 mg twice daily). Plasma fluticasone propionate concentrations following fluticasone propionate aqueous nasal spray alone were undetectable (less than 10 pg/mL) in most subjects, and when concentrations were detectable, peak levels ( $C_{max}$ ) averaged 11.9 pg/mL (range: 10.8 to 14.1 pg/mL) and  $AUC_{(0-T)}$  averaged 8.43 pg•hr/mL (range: 4.2 to 18.8 pg•hr/mL). Fluticasone propionate  $C_{max}$  and  $AUC_{(0-T)}$  increased to 318 pg/mL (range: 110 to 648 pg/mL) and 3,102.6 pg•hr/mL (range: 1,207.1 to 5,662.0 pg•hr/mL), respectively, after coadministration of ritonavir with fluticasone propionate aqueous nasal spray. This significant increase in plasma fluticasone propionate exposure resulted in a significant decrease (86%) in serum cortisol AUC.

*Ketoconazole:* In a placebo-controlled, crossover study in 8 healthy adult volunteers, coadministration of a single dose of orally inhaled fluticasone propionate (1,000 mcg) with multiple doses of ketoconazole (200 mg) to steady state resulted in increased plasma fluticasone propionate exposure, a reduction in plasma cortisol AUC, and no effect on urinary excretion of cortisol.

Following orally inhaled fluticasone propionate alone,  $AUC_{(2-last)}$  averaged 1.559 ng•hr/mL (range: 0.555 to 2.906 ng•hr/mL) and  $AUC_{(2-\infty)}$  averaged 2.269 ng•hr/mL (range: 0.836 to 3.707 ng•hr/mL). Fluticasone propionate  $AUC_{(2-last)}$  and  $AUC_{(2-\infty)}$  increased to 2.781 ng•hr/mL (range: 2.489 to 8.486 ng•hr/mL) and 4.317 ng•hr/mL (range: 3.256 to 9.408 ng•hr/mL), respectively, after coadministration of ketoconazole with orally inhaled fluticasone propionate. This increase in plasma fluticasone propionate concentration resulted in a decrease (45%) in serum cortisol AUC.

*Erythromycin:* In a multiple-dose drug interaction study, coadministration of orally inhaled fluticasone propionate (500 mcg twice daily) and erythromycin (333 mg 3 times daily) did not affect fluticasone propionate pharmacokinetics.

## 13 NONCLINICAL TOXICOLOGY

### 13.1 Carcinogenesis, Mutagenesis, Impairment of Fertility

Fluticasone propionate demonstrated no tumorigenic potential in mice at oral doses up to 1,000 mcg/kg (approximately 2 and 10 times the MRHD in adults and children aged 4 to 11 years, respectively, on a mg/m<sup>2</sup> basis) for 78 weeks or in rats at inhalation doses up to 57 mcg/kg (approximately 0.3 times and approximately equivalent to the MRHD in adults and children aged 4 to 11 years, respectively, on a mg/m<sup>2</sup> basis) for 104 weeks.

Fluticasone propionate did not induce gene mutation in prokaryotic or eukaryotic cells in vitro. No significant clastogenic effect was seen in cultured human peripheral lymphocytes in vitro or in the in vivo mouse micronucleus test.

No evidence of impairment of fertility was observed in reproductive studies conducted in male and female rats at subcutaneous doses up to 50 mcg/kg (approximately 0.2 times the MRHD in adults on a mg/m<sup>2</sup> basis). Prostate weight was significantly reduced at a subcutaneous dose of 50 mcg/kg.

### 13.2 Animal Toxicology and/or Pharmacology

*Reproductive Toxicology:* Subcutaneous studies in mice and rats at 45 and 100 mcg/kg (approximately 0.1 and 0.5 times the MRHD in adults on a mg/m<sup>2</sup> basis, respectively) revealed fetal toxicity characteristic of potent corticosteroid compounds, including embryonic growth retardation, omphalocele, cleft palate, and retarded cranial ossification.

In rabbits, fetal weight reduction and cleft palate were observed at a subcutaneous dose of 4 mcg/kg (approximately 0.04 times the MRHD in adults on a mg/m<sup>2</sup> basis). However, no teratogenic effects were reported at oral doses up to 300 mcg/kg (approximately 3 times the MRHD in adults on a mg/m<sup>2</sup> basis) of fluticasone propionate. No fluticasone propionate was detected in the plasma in this study, consistent with the established low bioavailability following oral administration [*see Clinical Pharmacology (12.3)*].

Fluticasone propionate crossed the placenta following subcutaneous administration to mice and rats and oral administration to rabbits.

In animals and humans, propellant HFA-134a was found to be rapidly absorbed and rapidly eliminated, with an elimination half-life of 3 to 27 minutes in animals and 5 to 7 minutes in humans. Time to maximum plasma concentration (T<sub>max</sub>) and mean residence time are both extremely short, leading to a transient appearance of HFA-134a in the blood with no evidence of accumulation.

Propellant HFA-134a is devoid of pharmacological activity except at very high doses in animals (i.e., 380 to 1,300 times the maximum human exposure based on comparisons of AUC values), primarily producing ataxia, tremors, dyspnea, or salivation. These events are similar to effects produced by the structurally related CFCs, which have been used extensively in metered-dose inhalers.

## **14 CLINICAL STUDIES**

### **14.1 Adult and Adolescent Patients Aged 12 Years and Older**

Three randomized, double-blind, parallel-group, placebo-controlled, US clinical trials were conducted in 980 adult and adolescent patients (aged 12 years and older) with asthma to assess the efficacy and safety of FLOVENT HFA in the treatment of asthma. Fixed dosages of 88, 220, and 440 mcg twice daily (each dose administered as 2 inhalations of the 44-, 110-, and 220-mcg strengths, respectively) and 880 mcg twice daily (administered as 4 inhalations of the 220-mcg strength) were compared with placebo to provide information about appropriate dosing to cover a range of asthma severity. Patients in these studies included those inadequately controlled with bronchodilators alone (Study 1), those already receiving inhaled corticosteroids (Study 2), and those requiring oral corticosteroid therapy (Study 3). In all 3 studies, patients (including placebo-treated patients) were allowed to use VENTOLIN<sup>®</sup> (albuterol, USP) Inhalation Aerosol as needed for relief of acute asthma symptoms. In Studies 1 and 2, other maintenance asthma therapies were discontinued.

Study 1 enrolled 397 patients with asthma inadequately controlled on bronchodilators alone. FLOVENT HFA was evaluated at dosages of 88, 220, and 440 mcg twice daily for 12 weeks. Baseline FEV<sub>1</sub> values were similar across groups (mean 67% of predicted normal). All 3 dosages of FLOVENT HFA demonstrated a statistically significant improvement in lung function as measured by improvement in AM pre-dose FEV<sub>1</sub> compared with placebo. This improvement was observed after the first week of treatment, and was maintained over the 12-week treatment period.

At Endpoint (last observation), mean change from baseline in AM pre-dose percent predicted FEV<sub>1</sub> was greater in all 3 groups treated with FLOVENT HFA (9.0% to 11.2%) compared with the placebo group (3.4%). The mean differences between the groups treated with FLOVENT HFA 88, 220, and 440 mcg and the placebo group were statistically significant, and the corresponding 95% confidence intervals were (2.2%, 9.2%), (2.8%, 9.9%), and (4.3%, 11.3%), respectively.

Figure 1 displays results of pulmonary function tests (mean percent change from baseline in FEV<sub>1</sub> prior to AM dose) for the recommended starting dosage of FLOVENT HFA (88 mcg twice daily) and placebo from Study 1. This trial used predetermined criteria for lack of efficacy (indicators of worsening asthma), resulting in withdrawal of more patients in the placebo group. Therefore, pulmonary function results at Endpoint (the last evaluable FEV<sub>1</sub> result, including most patients' lung function data) are also displayed.

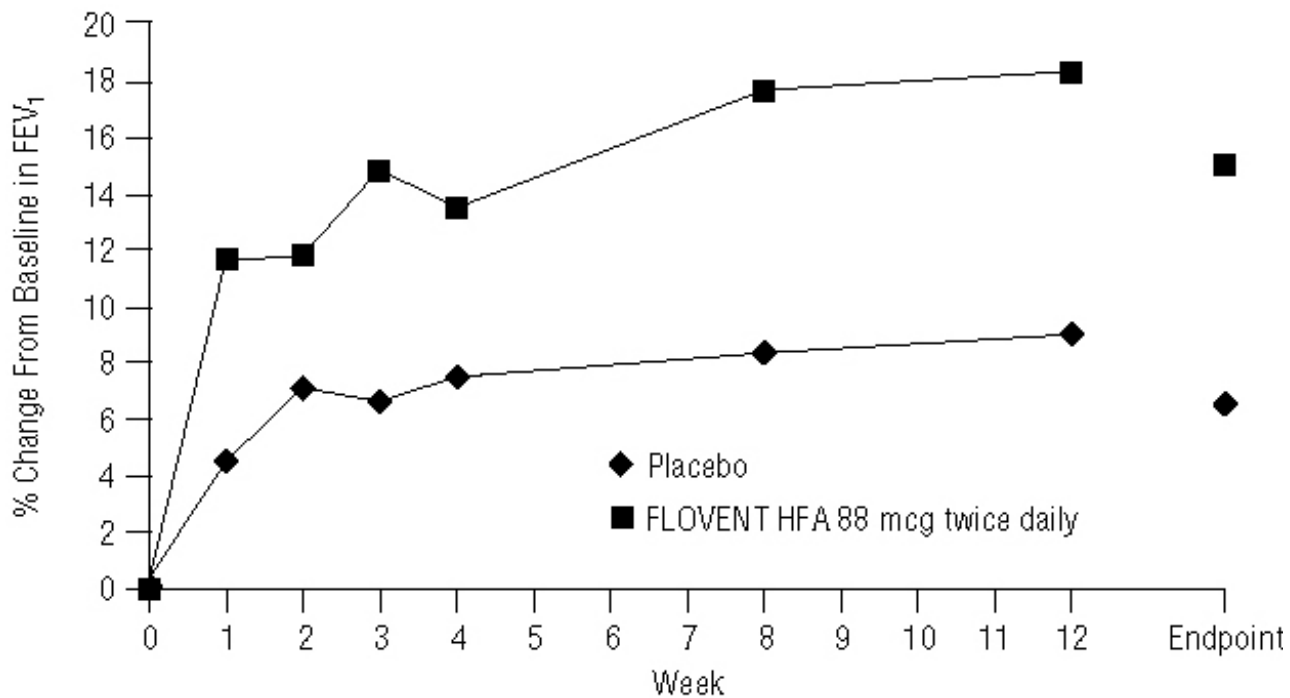
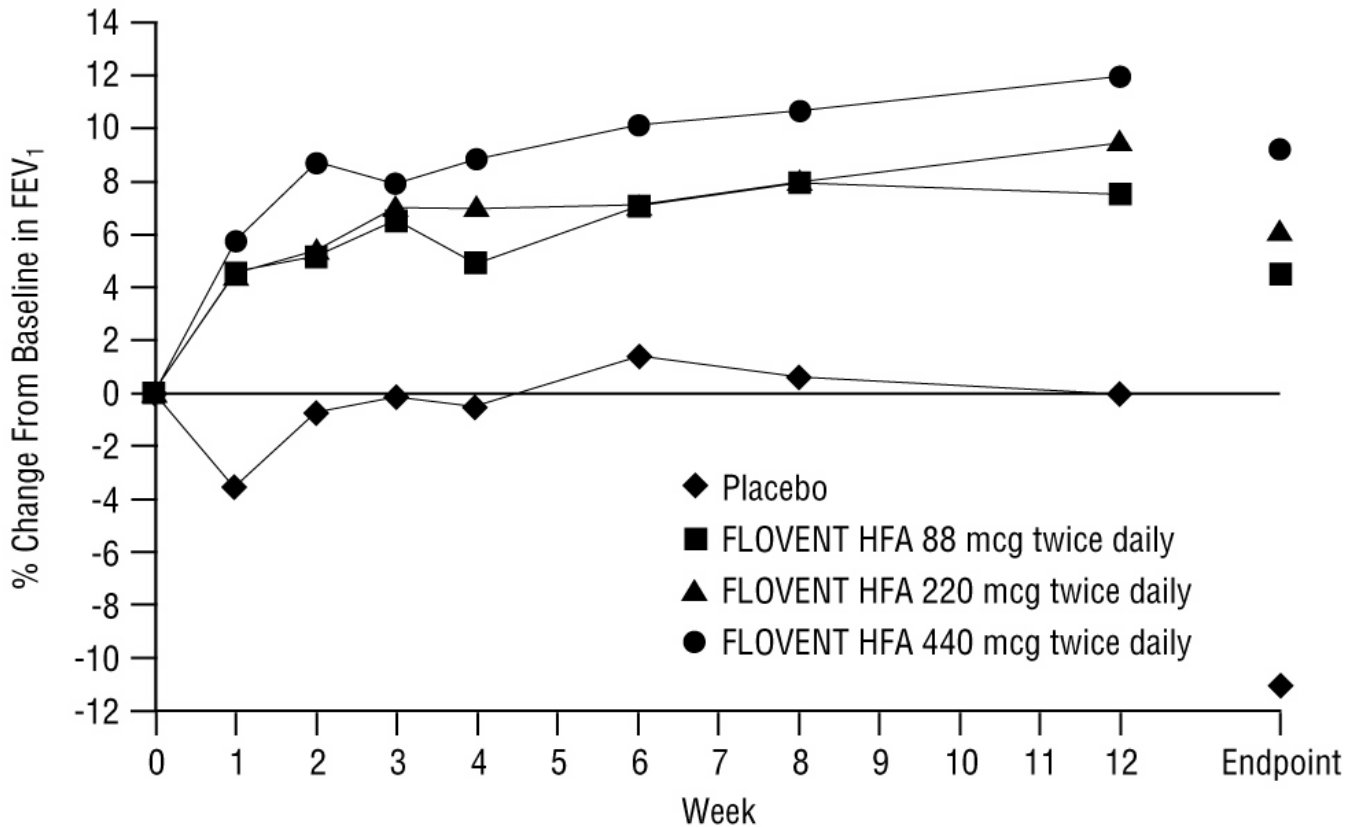

**Figure 1. A 12-Week Clinical Trial in Patients Aged 12 Years and Older Inadequately Controlled on Bronchodilators Alone: Mean Percent Change From Baseline in FEV<sub>1</sub> Prior to AM Dose (Study 1)**

In Study 2, FLOVENT HFA at dosages of 88, 220, and 440 mcg twice daily was evaluated over 12 weeks of treatment in 415 patients with asthma who were already receiving an inhaled corticosteroid at a daily dose within its recommended dose range in addition to as-needed albuterol. Baseline FEV<sub>1</sub> values were similar across groups (mean 65% to 66% of predicted normal). All 3 dosages of FLOVENT HFA demonstrated a statistically significant improvement in lung function, as measured by improvement in FEV<sub>1</sub>, compared with placebo. This improvement was observed after the first week of treatment and was maintained over the 12-week treatment period. Discontinuations from the study for lack of efficacy (defined by a pre-specified decrease in FEV<sub>1</sub> or PEF, or an increase in use of VENTOLIN or nighttime awakenings requiring treatment with VENTOLIN) were lower in the groups treated with FLOVENT HFA (6% to 11%) compared with placebo (50%).

At Endpoint (last observation), mean change from baseline in AM pre-dose percent predicted FEV<sub>1</sub> was greater in all 3 groups treated with FLOVENT HFA (2.2% to 4.6%) compared with the placebo group (-8.3%). The mean differences between the groups treated with FLOVENT HFA 88, 220, and 440 mcg and the placebo group were statistically significant, and the corresponding 95% confidence intervals were (7.1%, 13.8%), (8.2%, 14.9%), and (9.6%, 16.4%), respectively.

Figure 2 displays the mean percent change from baseline in FEV<sub>1</sub> from Week 1 through Week 12. This study also used predetermined criteria for lack of efficacy, resulting in withdrawal of more patients in the placebo group; therefore, pulmonary function results at Endpoint are also displayed.



**Figure 2. A 12-Week Clinical Trial in Patients Aged 12 Years and Older Already Receiving Daily Inhaled Corticosteroids: Mean Percent Change From Baseline in FEV<sub>1</sub> Prior to AM Dose (Study 2)**

In both studies, use of VENTOLIN, AM and PM PEF, and asthma symptom scores showed numerical improvement with FLOVENT HFA compared with placebo.

Study 3 enrolled 168 patients with asthma requiring oral prednisone therapy (average baseline daily prednisone dose ranged from 13 to 14 mg). FLOVENT HFA at dosages of 440 and 880 mcg twice daily was evaluated over a 16-week treatment period. Baseline FEV<sub>1</sub> values were similar across groups (mean 59% to 62% of predicted normal). Over the course of the study, patients treated with either dosage of FLOVENT HFA required a statistically significantly lower mean daily oral prednisone dose (6 mg) compared with placebo-treated patients (15 mg). Both dosages of FLOVENT HFA enabled a larger percentage of patients (59% and 56% in the groups treated with FLOVENT HFA 440 and 880 mcg, respectively, twice daily) to eliminate oral prednisone as compared with placebo (13%) (see Figure 3). There was no efficacy advantage of FLOVENT HFA 880 mcg twice daily compared with 440 mcg twice daily. Accompanying the reduction in oral corticosteroid use, patients treated with either dosage of FLOVENT HFA had statistically significantly improved lung function, fewer asthma symptoms, and less use of VENTOLIN Inhalation Aerosol compared with the placebo-treated patients.

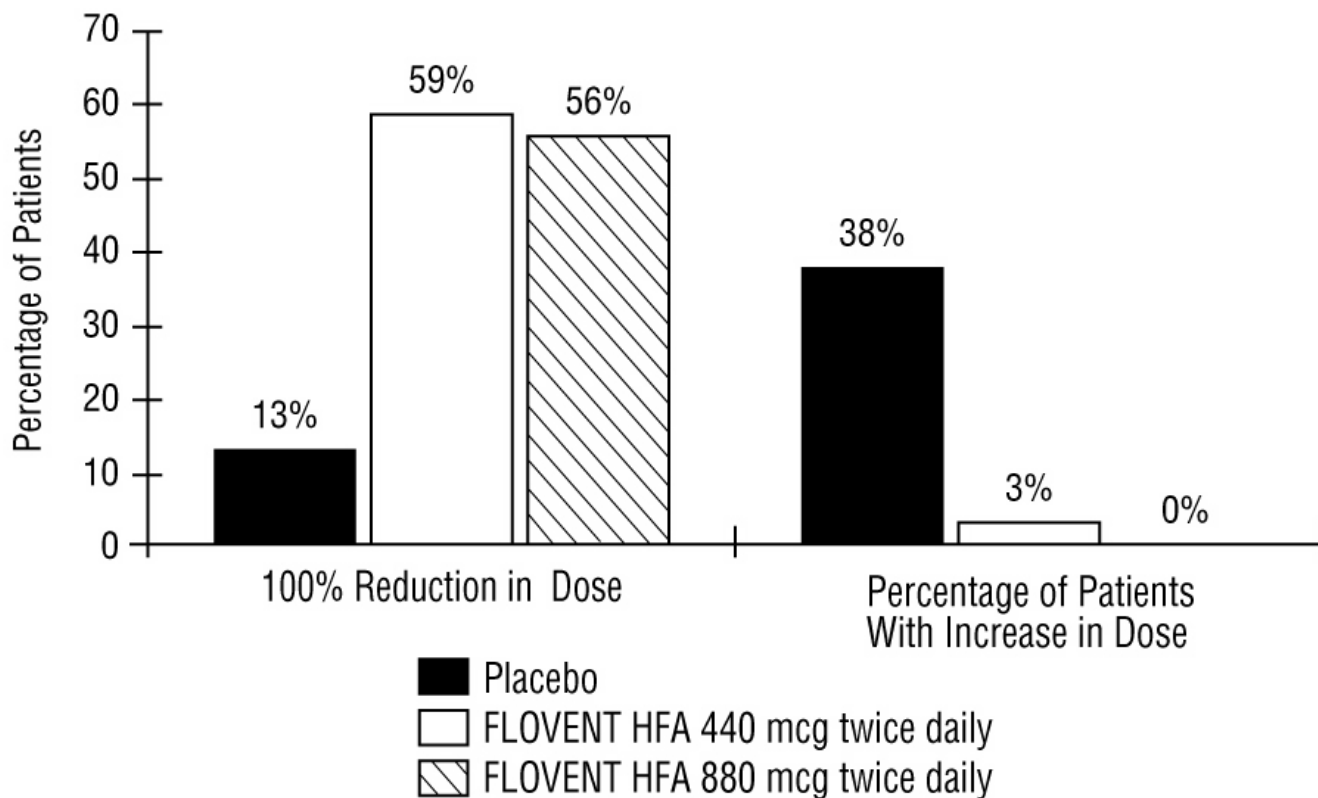

**Figure 3. A 16-Week Clinical Trial in Patients Aged 12 Years and Older Requiring Chronic Oral Prednisone Therapy: Change in Maintenance Prednisone Dose**

Two long-term safety studies (Study 4 and Study 5) of  $\geq 6$  months' duration were conducted in 507 adult and adolescent patients with asthma. Study 4 was designed to monitor the safety of 2 doses of FLOVENT HFA, while Study 5 compared fluticasone propionate HFA with fluticasone propionate CFC. Study 4 enrolled 182 patients who were treated daily with low to high doses of inhaled corticosteroids, beta-agonists (short-acting [as needed or regularly scheduled] or long-acting), theophylline, inhaled cromolyn or nedocromil sodium, leukotriene receptor antagonists, or 5-lipoxygenase inhibitors at baseline. FLOVENT HFA at dosages of 220 and 440 mcg twice daily was evaluated over a 26-week treatment period in 89 and 93 patients, respectively. Study 5 enrolled 325 patients who were treated daily with moderate to high doses of inhaled corticosteroids, with or without concurrent use of salmeterol or albuterol, at baseline. Fluticasone propionate HFA at a dosage of 440 mcg twice daily and fluticasone propionate CFC at a dosage of 440 mcg twice daily were evaluated over a 52-week treatment period in 163 and 162 patients, respectively. Baseline FEV<sub>1</sub> values were similar across groups (mean 81% to 84% of predicted normal). Throughout the 52-week treatment period, asthma control was maintained with both formulations of fluticasone propionate compared with baseline. In both studies, none of the patients were withdrawn due to lack of efficacy.

#### 14.2 Pediatric Patients Aged 4 to 11 Years

A 12-week clinical trial conducted in 241 pediatric patients with asthma was supportive of efficacy but inconclusive due to measurable levels of fluticasone propionate in 6/48 (13%) of the plasma samples from patients randomized to placebo. Efficacy in patients aged 4 to 11 years is extrapolated from adult data with FLOVENT HFA and other supporting data [see *Use in Specific Populations (8.4)*].

#### 16 HOW SUPPLIED/STORAGE AND HANDLING

FLOVENT HFA 44 mcg Inhalation Aerosol is supplied in 10.6-g pressurized aluminum canisters

containing 120 metered inhalations in boxes of 1 (NDC 54868-5995-0).

FLOVENT HFA 110 mcg Inhalation Aerosol is supplied in 12-g pressurized aluminum canisters containing 120 metered inhalations in boxes of 1 (NDC 54868-5362-0).

FLOVENT HFA 220 mcg Inhalation Aerosol is supplied in 12-g pressurized aluminum canisters containing 120 metered inhalations in boxes of 1 (NDC 54868-5637-0).

Each canister is fitted with a counter and a dark orange oral actuator with a peach strapcap packaged within a plastic-coated, moisture-protective foil pouch and patient's instructions. The moisture-protective foil pouch also contains a desiccant that should be discarded when the pouch is opened.

The dark orange actuator supplied with FLOVENT HFA should not be used with any other product canisters, and actuators from other products should not be used with a FLOVENT HFA canister.

The correct amount of medication in each inhalation cannot be assured after the counter reads 000, even though the canister is not completely empty and will continue to operate. The inhaler should be discarded when the counter reads 000.

Keep out of reach of children. Avoid spraying in eyes.

Contents Under Pressure: Do not puncture. Do not use or store near heat or open flame. Exposure to temperatures above 120°F may cause bursting. Never throw into fire or incinerator.

Store at 25°C (77°F); excursions permitted from 15° to 30°C (59° to 86°F). Store the inhaler with the mouthpiece down. For best results, the inhaler should be at room temperature before use. SHAKE WELL BEFORE USING.

FLOVENT HFA does not contain CFCs as the propellant.

## **17 PATIENT COUNSELING INFORMATION**

See FDA-approved patient labeling (*Patient Information and Instructions for Use*).

### **17.1 Oral Candidiasis**

Patients should be advised that localized infections with *Candida albicans* have occurred in the mouth and pharynx in some patients. If oropharyngeal candidiasis develops, it should be treated with appropriate local or systemic (i.e., oral antifungal) therapy while still continuing therapy with FLOVENT HFA, but at times therapy with FLOVENT HFA may need to be temporarily interrupted under close medical supervision. Rinsing the mouth after inhalation is advised.

### **17.2 Status Asthmaticus and Acute Asthma Symptoms**

Patients should be advised that FLOVENT HFA is not a bronchodilator and is not intended for use as rescue medication for acute asthma exacerbations. Acute asthma symptoms should be treated with an inhaled, short-acting beta<sub>2</sub>-agonist such as albuterol. Patients should be instructed to contact their physicians immediately if there is deterioration of their asthma.

### **17.3 Immunosuppression**

Patients who are on immunosuppressant doses of corticosteroids should be warned to avoid exposure to chickenpox or measles and if they are exposed to consult their physicians without delay. Patients should be informed of potential worsening of existing tuberculosis, fungal, bacterial, viral, or parasitic infections, or ocular herpes simplex.

### **17.4 Hypercorticism and Adrenal Suppression**

Patients should be advised that FLOVENT HFA may cause systemic corticosteroid effects of hypercorticism and adrenal suppression. Additionally, patients should be instructed that deaths due to adrenal insufficiency have occurred during and after transfer from systemic corticosteroids. Patients

should taper slowly from systemic corticosteroids if transferring to FLOVENT HFA.

### **17.5 Hypersensitivity Reactions, Including Anaphylaxis**

Patients should be advised that hypersensitivity reactions including anaphylaxis, angioedema, urticaria, and bronchospasm may occur after administration of FLOVENT HFA. Patients should discontinue FLOVENT HFA if such reactions occur.

### **17.6 Reduction in Bone Mineral Density**

Patients who are at an increased risk for decreased BMD should be advised that the use of corticosteroids may pose an additional risk.

### **17.7 Reduced Growth Velocity**

Patients should be informed that orally inhaled corticosteroids, including FLOVENT HFA, may cause a reduction in growth velocity when administered to pediatric patients. Physicians should closely follow the growth of children and adolescents taking corticosteroids by any route.

### **17.8 Ocular Effects**

Long-term use of inhaled corticosteroids may increase the risk of some eye problems (cataracts or glaucoma); regular eye examinations should be considered.

### **17.9 Use Daily for Best Effect**

Patients should use FLOVENT HFA at regular intervals as directed. Individual patients will experience a variable time to onset and degree of symptom relief and the full benefit may not be achieved until treatment has been administered for 1 to 2 weeks or longer. Patients should not increase the prescribed dosage but should contact their physicians if symptoms do not improve or if the condition worsens. Patients should be instructed not to stop use of FLOVENT HFA abruptly. Patients should contact their physicians immediately if they discontinue use of FLOVENT HFA.

DISKUS, FLOVENT, ROTADISK, and VENTOLIN are registered trademarks of GlaxoSmithKline.

AeroChamber Plus is a registered trademark and AeroChamber Z-STAT Plus is a trademark of Monaghan Medical Corp. or an affiliate of Monaghan Medical Corp.

GlaxoSmithKline

Research Triangle Park, NC 27709

©2012, GlaxoSmithKline. All rights reserved.

January 2012

FLH:4PI

### **Additional barcode labeling by:**

Physicians Total Care, Inc.

Tulsa, Oklahoma 74146

PHARMACIST—DETACH HERE AND GIVE LEAFLET TO PATIENT

### **Patient Information**

**FLOVENT<sup>®</sup> [flō' vent] HFA 44 mcg**

**(fluticasone propionate 44 mcg)**

## **Inhalation Aerosol**

**FLOVENT® HFA 110 mcg**

**(fluticasone propionate 110 mcg)**

## **Inhalation Aerosol**

**FLOVENT® HFA 220 mcg**

**(fluticasone propionate 220 mcg)**

## **Inhalation Aerosol**

### **FOR ORAL INHALATION ONLY**

Read this leaflet carefully before you start to use FLOVENT HFA Inhalation Aerosol.

Keep this leaflet because it has important summary information about FLOVENT HFA. This leaflet does not contain all the information about your medicine. If you have any questions or are not sure about something, you should ask your doctor or pharmacist.

Read the new leaflet that comes with each refill of your prescription because there may be new information.

### **What is FLOVENT HFA?**

FLOVENT HFA contains a medicine called fluticasone propionate, which is a synthetic corticosteroid. Corticosteroids are natural substances found in the body that help fight inflammation. Corticosteroids are used to treat asthma because they reduce airway inflammation.

FLOVENT HFA is used to treat asthma in patients 4 years and older. When inhaled regularly, FLOVENT HFA also helps to prevent symptoms of asthma.

FLOVENT HFA comes in 3 strengths. Your doctor has prescribed the one that is best for your condition.

### **Who should not use FLOVENT HFA?**

Do not use FLOVENT HFA if you:

- are allergic to any of the ingredients in FLOVENT HFA or other inhaled corticosteroids. See “What are the ingredients in FLOVENT HFA?” below.
- have an acute asthma attack or status asthmaticus. **FLOVENT HFA is not a bronchodilator and should not be used to give you fast relief from your breathing problems during an asthma attack.** Always use a short-acting bronchodilator (rescue medicine), such as albuterol inhaler, during a sudden asthma attack. You must take FLOVENT HFA at regular times as recommended by your doctor, and not as an emergency medicine.

### **What should I tell my doctor before taking FLOVENT HFA?**

**Tell your doctor if you:**

- have liver problems.
- have been exposed to chickenpox or measles.
- have any other medical conditions.
- are pregnant or planning to become pregnant. It is not known if FLOVENT HFA will harm your unborn baby.
- are breastfeeding a baby. It is not known if FLOVENT HFA passes into your breast milk.

Tell your doctor about all the medicines you take including prescription and non-prescription medicines, vitamins, and herbal supplements. FLOVENT HFA may affect the way other medicines work, and other medicines may affect how FLOVENT HFA works. Especially, tell your doctor if you take:

- a medicine containing ritonavir (commonly used to treat HIV infection or AIDS). The anti-HIV



medicines NORVIR<sup>®</sup> (ritonavir capsules) Soft Gelatin, NORVIR (ritonavir oral solution), and KALETRA<sup>®</sup> (lopinavir/ritonavir) tablets contain ritonavir.

- any other corticosteroid medicines.
- ketoconazole (NIZORAL<sup>®</sup>), an antifungal medicine.

### **How should I use FLOVENT HFA?**

1. It is important that you inhale each dose as your doctor has prescribed. The prescription label provided by your pharmacist will usually tell you what dose to take and how often. If it doesn't or if you aren't sure, ask your doctor or pharmacist. **DO NOT** inhale more doses or use your FLOVENT HFA more often than your doctor has prescribed.
2. It may take 1 to 2 weeks or longer for this medicine to work, and it is very important that you use it regularly. **Do not stop taking FLOVENT HFA, even if you are feeling better, unless your doctor tells you to.**
3. If you miss a dose, just take your next scheduled dose when it is due. **Do not double the dose.**
4. Your doctor may prescribe additional medicine (such as fast-acting bronchodilators) for emergency relief if a sudden asthma attack occurs. Contact your doctor if:
  - an asthma attack does not respond to the additional medicine or
  - you need more of the additional medicine than usual.
5. If you also use another medicine by inhalation, you should ask your doctor for instructions on when to use it while you are also using FLOVENT HFA.
6. Children should use FLOVENT HFA with an adult's help, as instructed by the child's healthcare provider. A valved holding chamber (a kind of spacer) and face mask may be used to deliver FLOVENT HFA to young patients.

### **What should I avoid while taking FLOVENT HFA?**

If you have not had or not been vaccinated against chickenpox, measles, or active tuberculosis, you should stay away from people who are infected.

### **What are the possible side effects of FLOVENT HFA?**

FLOVENT HFA can cause serious side effects, including:

- **fungal infections (thrush) in your mouth and throat.** Tell your doctor if you have any redness or white-colored coating in your mouth
- **decreased ability to fight infections.** Symptoms of infection may include: fever, pain, aches, chills, feeling tired, nausea and vomiting. Tell your doctor about any signs of infection while you use FLOVENT HFA.
- **decreased adrenal function (adrenal insufficiency).** Symptoms of decreased adrenal function include tiredness, weakness, nausea and vomiting, and low blood pressure. Decreased adrenal function can lead to death
- **allergic reaction (anaphylaxis).** Call your doctor and stop FLOVENT HFA right away if you have any symptoms of an allergic reaction:
  - swelling of the face, throat and tongue
  - hives
  - rash
  - breathing problems
- **lower bone mineral density.** This may be a problem for people who already have a higher chance of low bone density (osteoporosis).
- **slow growth in children.** The growth of children using FLOVENT HFA should be checked regularly.
- **eye problems including glaucoma and cataracts.** Tell your doctor about any vision changes

while using FLOVENT HFA. Your doctor may tell you to have your eyes checked.

- **increased wheezing (bronchospasm).** Increased wheezing can happen right away after using FLOVENT HFA. Always have a rescue inhaler with you to treat sudden wheezing.

Tell your doctor right away if you have any of the serious side effects listed above or if you have worsening lung symptoms.

The most common side effects of FLOVENT HFA include:

- a cold or upper respiratory tract infection
- throat irritation
- headache
- fever
- diarrhea
- ear infection

Tell your doctor if you have any side effects that bother you or that do not go away. These are not all the possible side effects of FLOVENT HFA. For more information ask your doctor or pharmacist.

Call your doctor for medical advice about side effects. You may report side effects to FDA at 1-800-FDA-1088 or 1-800-332-1088.

### **How should I store FLOVENT HFA?**

Store FLOVENT HFA at room temperature between 59°and 86°F (15°-30°C). Store the inhaler with the mouthpiece down. For best results, the inhaler should be at room temperature before use.

### **Keep FLOVENT HFA and all medicines out of the reach of children.**

This Patient Information leaflet summarizes the most important information about FLOVENT HFA. If you would like more information, talk with your healthcare provider. You can ask your pharmacist or doctor for information about FLOVENT HFA that is written for health professionals. You can also contact the company that makes FLOVENT HFA (toll free) at 1-888-825-5249.

### **What are the ingredients in FLOVENT HFA?**

Active ingredient: fluticasone propionate (micronized)

Inactive ingredient: propellant HFA-134a

### **Instructions for Using FLOVENT HFA**

#### **The parts of your FLOVENT HFA**

There are 2 main parts to your FLOVENT HFA inhaler—the metal canister that holds the medicine and the dark orange plastic actuator that sprays the medicine from the canister (see Figure 1).

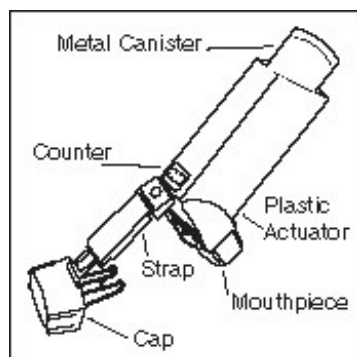

**Figure 1**

The canister has a counter to show how many sprays of medicine you have left. The number shows

through a window in the back of the actuator. The counter starts at 124. The number will count down by 1 each time you spray the inhaler. The counter will stop counting at 000.

**Never try to change the numbers or take the counter off the metal canister.** The counter cannot be reset, and it is permanently attached to the canister.

The mouthpiece of the actuator is covered by a cap. A strap on this cap keeps it attached to the actuator.

**Do not use the actuator with a canister of medicine from any other inhaler. And do not use a FLOVENT HFA canister with an actuator from any other inhaler.**

### Using your FLOVENT HFA

- The inhaler should be at room temperature before you use it.
- Take your FLOVENT HFA inhaler out of the moisture-protective foil pouch just before you use it for the first time. Safely throw away the foil pouch and the drying packet that comes inside the pouch.
- **Priming the inhaler:**  
**Before you use FLOVENT HFA for the first time, you must prime the inhaler so that you will get the right amount of medicine when you use it.** To prime the inhaler, take the cap off the mouthpiece and shake the inhaler well for 5 seconds. Then spray the inhaler into the air away from your face. **Avoid spraying in eyes.** Shake and spray the inhaler like this 3 more times to finish priming it. The counter should now read 120.  
You must prime the inhaler again if you have not used it in more than 7 days or if you drop it. Take the cap off the mouthpiece and shake the inhaler well for 5 seconds. Then spray it 1 time into the air away from your face.
- If a child needs help using the inhaler, an adult should help the child use the inhaler with or without a valved holding chamber, which may also be attached to a face mask. The adult should follow the instructions that came with the valved holding chamber. An adult should watch a child use the inhaler to be sure it is used correctly.

Read the following 7 steps before using FLOVENT HFA and follow them at each use. If you have any questions, ask your doctor or pharmacist.

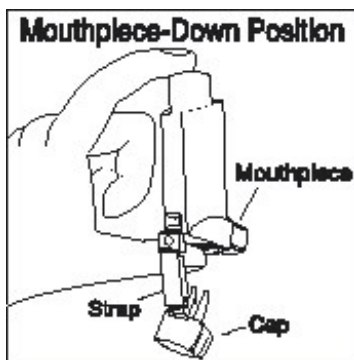
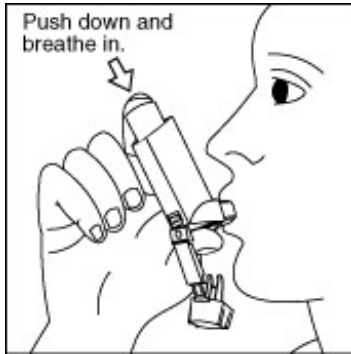

Figure 2

1. **Take the cap off the mouthpiece of the actuator** (see Figure 2). Look inside the mouthpiece for foreign objects, and take out any you see.  
Make sure the canister fits firmly in the actuator.  
**Shake the inhaler well** for 5 seconds.
2. Hold the inhaler with the mouthpiece down (see Figure 2). **Breathe out through your mouth** and push as much air from your lungs as you can. Put the mouthpiece in your mouth and close your lips around it.
3. Push the top of the canister all the way down while you breathe in deeply and slowly through your mouth (see Figure 3).

Right after the spray comes out, take your finger off the canister. After you have breathed in all the way, take the inhaler out of your mouth and close your mouth.

4. **Hold your breath as long as you can**, up to 10 seconds. Then breathe normally.
5. **Wait about 30 seconds and shake the inhaler well** for 5 seconds. Repeat steps 2 through 4.
6. After you finish taking this medicine, rinse your mouth with water. Spit out the water. Do not swallow it.
7. Put the cap back on the mouthpiece after each time you use the inhaler. Make sure it snaps firmly into place.



**Figure 3**

### **Cleaning your FLOVENT HFA**

Clean the inhaler at least once a week after your evening dose. It is important to keep the canister and plastic actuator clean so the medicine will not build-up and block the spray.

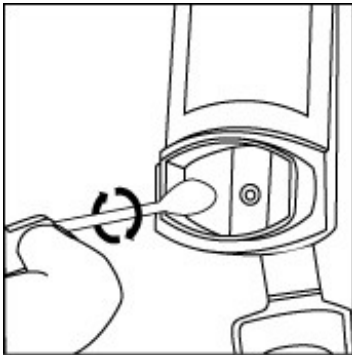

**Figure 4**

1. Take the cap off the mouthpiece. The strap on the cap will stay attached to the actuator. Do not take the canister out of the plastic actuator.
2. Use a clean cotton swab dampened with water to clean the small circular opening where the medicine sprays out of the canister. Gently twist the swab in a circular motion to take off any medicine (see Figure 4). Repeat with a new swab dampened with water to take off any medicine still at the opening.
3. Wipe the inside of the mouthpiece with a clean tissue dampened with water. Let the actuator air-dry overnight.
4. Put the cap back on the mouthpiece after the actuator has dried.

### **Replacing your FLOVENT HFA**

- **When the counter reads 020**, you should refill your prescription or ask your doctor if you need a refill of your prescription.
- **When the counter reads 000**, throw the inhaler away. You should not keep using the inhaler

because you will not receive the right amount of medicine.

- **Do not use the inhaler** after the expiration date, which is on the packaging it comes in.

FLOVENT is a registered trademark of GlaxoSmithKline.

The other brands listed are trademarks of their respective owners and are not trademarks of GlaxoSmithKline. The makers of these brands are not affiliated with and do not endorse GlaxoSmithKline or its products.

GlaxoSmithKline

Research Triangle Park, NC 27709

©2010, GlaxoSmithKline. All rights reserved.

November 2010

FLH:2PIL

**Principal Display Panel**

**NDC 54868-5995-0**

**Flovent® HFA 44 mcg**

**(fluticasone propionate 44 mcg) Inhalation Aerosol**

**With Dose Counter**

**R<sub>x</sub> only**

**FOR ORAL INHALATION ONLY**

**Contents:** Each canister contains a microcrystalline suspension of fluticasone propionate (micronized) in propellant HFA-134a (1,1,1,2-tetrafluoroethane).

Each actuation of the inhaler delivers 50 mcg of fluticasone propionate from the valve and 44 mcg from the actuator.

**IMPORTANT:** Read accompanying Patient Information leaflet carefully for further information.

**Dosage:** Use only as directed by your doctor.

Store at 25°C (77°F); excursions permitted to 15°-30°C (59°-86°F).

**Net Wt. 10.6g 120 Metered Actuations**

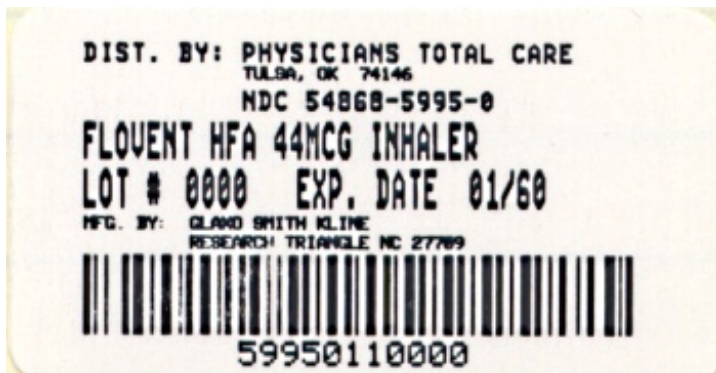

**Principal Display Panel**

**NDC 54868-5362-0**

**Flovent® HFA 110 mcg**

**(fluticasone propionate 110 mcg) Inhalation Aerosol**

**With Dose Counter**

**R<sub>x</sub> only**

**FOR ORAL INHALATION ONLY**

**Contents:** Each canister contains a microcrystalline suspension of fluticasone propionate (micronized) in propellant HFA-134a (1,1,1,2-tetrafluoroethane).

Each actuation of the inhaler delivers 125 mcg of fluticasone propionate from the valve and 110 mcg from the actuator.

**IMPORTANT:** Read accompanying Patient Information leaflet carefully for further information.

**Dosage:** Use only as directed by your doctor.

Store at 25°C (77°F); excursions permitted to 15°-30°C (59°-86°F).

**Net Wt. 12g 120 Metered Actuations**

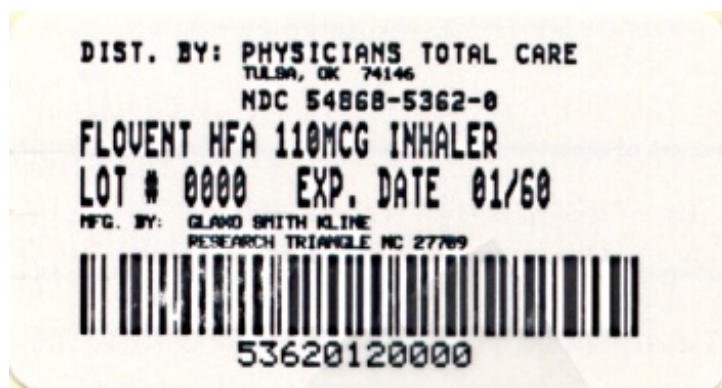

**Principal Display Panel**

**NDC 54868-5637-0**

**Flovent<sup>®</sup> HFA 220 mcg**

**(fluticasone propionate 220 mcg) Inhalation Aerosol**

**With Dose Counter**

**R<sub>x</sub> only**

**FOR ORAL INHALATION ONLY**

**Contents:** Each canister contains a microcrystalline suspension of fluticasone propionate (micronized) in propellant HFA-134a (1,1,1,2-tetrafluoroethane).

Each actuation of the inhaler delivers 250 mcg of fluticasone propionate from the valve and 220 mcg from the actuator.

**IMPORTANT:** Read accompanying Patient Information leaflet carefully for further information.

**Dosage:** Use only as directed by your doctor.

Store at 25°C (77°F); excursions permitted to 15°-30°C (59°-86°F).

**Net Wt. 12g 120 Metered Actuations**

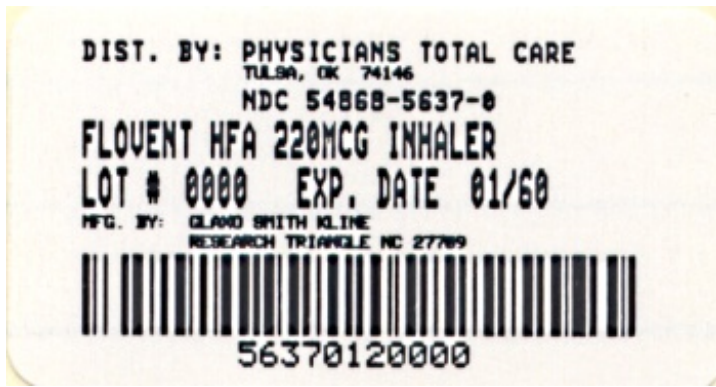

## FLOVENT HFA

fluticasone propionate aerosol, metered

### Product Information

Product Type	HUMAN PRESCRIPTION DRUG	Item Code (Source)	NDC:54868-5995(NDC:0173-0718)
Route of Administration	RESPIRATORY (INHALATION)		

### Active Ingredient/Active Moiety

Ingredient Name	Basis of Strength	Strength
FLUTICASONE PROPIONATE (UNII: O2GMZ0LF5W) (FLUTICASONE - UNII:CUT2W21N7U)	FLUTICASONE PROPIONATE	44 ug

### Inactive Ingredients

Ingredient Name	Strength
NORFLURANE (UNII: DH9E53K1Y8)	

### Packaging

#	Item Code	Package Description	Marketing Start Date	Marketing End Date
1	NDC:54868-5995-0	120 in 1 INHALER		

### Marketing Information

Marketing Category	Application Number or Monograph Citation	Marketing Start Date	Marketing End Date
NDA	NDA021433	02/26/2009	

## FLOVENT HFA

fluticasone propionate aerosol, metered

### Product Information

Product Type	HUMAN PRESCRIPTION DRUG	Item Code (Source)	NDC:54868-5362(NDC:0173-0719)
--------------	-------------------------	--------------------	-------------------------------

**Route of Administration** RESPIRATORY (INHALATION)

### Active Ingredient/Active Moiety

Ingredient Name	Basis of Strength	Strength
FLUTICASONE PROPIONATE (UNII: O2GMZ0LF5W) (FLUTICASONE - UNII:CUT2W21N7U)	FLUTICASONE PROPIONATE	110 ug

### Inactive Ingredients

Ingredient Name	Strength
NORFLURANE (UNII: DH9E53K1Y8)	

### Packaging

#	Item Code	Package Description	Marketing Start Date	Marketing End Date
1	NDC:54868-5362-0	120 in 1 INHALER		

### Marketing Information

Marketing Category	Application Number or Monograph Citation	Marketing Start Date	Marketing End Date
NDA	NDA021433	07/13/2005	

## FLOVENT HFA

fluticasone propionate aerosol, metered

### Product Information

<b>Product Type</b>	HUMAN PRESCRIPTION DRUG	<b>Item Code (Source)</b>	NDC:54868-5637(NDC:0173-0720)
<b>Route of Administration</b>	RESPIRATORY (INHALATION)		

### Active Ingredient/Active Moiety

Ingredient Name	Basis of Strength	Strength
FLUTICASONE PROPIONATE (UNII: O2GMZ0LF5W) (FLUTICASONE - UNII:CUT2W21N7U)	FLUTICASONE PROPIONATE	220 ug

### Inactive Ingredients

Ingredient Name	Strength
NORFLURANE (UNII: DH9E53K1Y8)	

### Packaging

#	Item Code	Package Description	Marketing Start Date	Marketing End Date
1	NDC:54868-5637-0	120 in 1 INHALER		



## Marketing Information

Marketing Category	Application Number or Monograph Citation	Marketing Start Date	Marketing End Date
NDA	NDA021433	07/05/2006	

**Labeler** - Physicians Total Care, Inc. (194123980)

## Establishment

Name	Address	ID/FEI	Business Operations
Physicians Total Care, Inc.		194123980	relabel

Revised: 1/2012

Physicians Total Care, Inc.