

VITRAKVI- larotrectinib capsule
VITRAKVI- larotrectinib solution
Loxo Oncology, Inc.

HIGHLIGHTS OF PRESCRIBING INFORMATION

These highlights do not include all the information needed to use VITRAKVI safely and effectively. See full prescribing information for VITRAKVI.

VITRAKVI® (larotrectinib) capsules, for oral use

VITRAKVI® (larotrectinib) oral solution

Initial U.S. Approval: 2018

----- **INDICATIONS AND USAGE** -----

VITRAKVI is a kinase inhibitor indicated for the treatment of adult and pediatric patients with solid tumors that:

- have a neurotrophic receptor tyrosine kinase (*NTRK*) gene fusion without a known acquired resistance mutation,
- are metastatic or where surgical resection is likely to result in severe morbidity, and
- have no satisfactory alternative treatments or that have progressed following treatment.

This indication is approved under accelerated approval based on overall response rate and duration of response. Continued approval for this indication may be contingent upon verification and description of clinical benefit in confirmatory trials (1,14).

----- **DOSAGE AND ADMINISTRATION** -----

- Select patients for treatment with VITRAKVI based on the presence of a *NTRK* gene fusion (2.1, 14).
- Recommended Dosage in Adult and Pediatric Patients with Body Surface Area of at Least 1.0 Meter-Squared: 100 mg orally twice daily (2.2)
- Recommended Dosage in Pediatric Patients with Body Surface Area of Less Than 1.0 Meter-Squared: 100 mg/m² orally twice daily (2.2)

----- **DOSAGE FORMS AND STRENGTHS** -----

- Capsules: 25 mg, 100 mg (3)
- Oral Solution: 20 mg/mL (3)

----- **CONTRAINDICATIONS** -----

None. (4)

----- **WARNINGS AND PRECAUTIONS** -----

- Neurotoxicity: Advise patients and caretakers of the risk of neurologic adverse reactions. Advise patients not to drive or operate hazardous machinery if experiencing neurotoxicity. Withhold and modify dosage, or permanently discontinue VITRAKVI based on severity. (2.3, 5.1)
- Hepatotoxicity: Monitor liver tests including ALT and AST every 2 weeks during the first month of treatment, then monthly thereafter and as clinically indicated. Withhold and modify dosage, or permanently discontinue VITRAKVI based on severity. (2.6, 5.2)
- Embryo-Fetal Toxicity: Can cause fetal harm. Advise females with reproductive potential of potential risk to the fetus and to use effective contraception. (5.3, 8.3)

----- **ADVERSE REACTIONS** -----

The most common adverse reactions (≥ 20%) with VITRAKVI were fatigue, nausea, dizziness, vomiting, increased AST, cough, increased ALT, constipation, and diarrhea. (6).

To report SUSPECTED ADVERSE REACTIONS, contact Bayer HealthCare Pharmaceuticals Inc. at 1-888-842-2937 or FDA at 1-800-FDA-1088 or www.fda.gov/medwatch.

----- **DRUG INTERACTIONS** -----

- Strong CYP3A4 Inhibitors: Avoid coadministration of strong CYP3A4 inhibitors with VITRAKVI. If coadministration cannot be avoided, reduce the VITRAKVI dose. (2.4, 7.1)
- Strong CYP3A4 Inducers: Avoid coadministration of strong CYP3A4 inducers with VITRAKVI. If coadministration cannot be avoided, increase the VITRAKVI dose. (2.5, 7.1)

- Sensitive CYP3A4 Substrates: Avoid coadministration of sensitive CYP3A4 substrates with VITRAKVI. (7.2)

----- **USE IN SPECIFIC POPULATIONS** -----

- Lactation: Advise not to breastfeed. (8.2)
- Hepatic Impairment: Reduce the starting dose of VITRAKVI in patients with moderate (Child-Pugh B) to severe (Child-Pugh C) hepatic impairment. (2.6, 8.7)

See 17 for **PATIENT COUNSELING INFORMATION** and **FDA-approved patient labeling**.

Revised: 12/2018

FULL PRESCRIBING INFORMATION: CONTENTS*

1 INDICATIONS AND USAGE

2 DOSAGE AND ADMINISTRATION

- 2.1 Patient Selection
- 2.2 Recommended Dosage
- 2.3 Dosage Modifications for Adverse Reactions
- 2.4 Dosage Modifications for Coadministration with Strong CYP3A4 Inhibitors
- 2.5 Dosage Modifications for Coadministration with Strong CYP3A4 Inducers
- 2.6 Dosage Modifications for Patients with Hepatic Impairment
- 2.7 Administration

3 DOSAGE FORMS AND STRENGTHS

4 CONTRAINDICATIONS

5 WARNINGS AND PRECAUTIONS

- 5.1 Neurotoxicity
- 5.2 Hepatotoxicity
- 5.3 Embryo-Fetal Toxicity

6 ADVERSE REACTIONS

- 6.1 Clinical Trial Experience

7 DRUG INTERACTIONS

- 7.1 Effects of Other Drugs on VITRAKVI
- 7.2 Effects of VITRAKVI on Other Drugs

8 USE IN SPECIFIC POPULATIONS

- 8.1 Pregnancy
- 8.2 Lactation
- 8.3 Females and Males of Reproductive Potential
- 8.4 Pediatric Use
- 8.5 Geriatric Use
- 8.6 Hepatic Impairment
- 8.7 Renal Impairment

11 DESCRIPTION

12 CLINICAL PHARMACOLOGY

- 12.1 Mechanism of Action
- 12.2 Pharmacodynamics
- 12.3 Pharmacokinetics

13 NONCLINICAL TOXICOLOGY

- 13.1 Carcinogenesis, Mutagenesis, Impairment of Fertility
- 13.2 Animal Toxicology and/or Pharmacology

14 CLINICAL STUDIES

16 HOW SUPPLIED/STORAGE AND HANDLING

17 PATIENT COUNSELING INFORMATION

* Sections or subsections omitted from the full prescribing information are not listed.

FULL PRESCRIBING INFORMATION

1 INDICATIONS AND USAGE

VITRAKVI is indicated for the treatment of adult and pediatric patients with solid tumors that:

- have a neurotrophic receptor tyrosine kinase (*NTRK*) gene fusion without a known acquired resistance mutation,
- are metastatic or where surgical resection is likely to result in severe morbidity, and
- have no satisfactory alternative treatments or that have progressed following treatment.

This indication is approved under accelerated approval based on overall response rate and duration of response [see *Clinical Studies (14)*]. Continued approval for this indication may be contingent upon verification and description of clinical benefit in confirmatory trials.

2 DOSAGE AND ADMINISTRATION

2.1 Patient Selection

Select patients for treatment with VITRAKVI based on the presence of a *NTRK* gene fusion in tumor specimens [see *Clinical Studies (14)*]. An FDA-approved test for the detection of *NTRK* gene fusion is not currently available.

2.2 Recommended Dosage

Recommended Dosage in Adult and Pediatric Patients with Body Surface Area of at Least 1.0 Meter-Squared

The recommended dosage of VITRAKVI is 100 mg orally twice daily, with or without food, until disease progression or until unacceptable toxicity.

Recommended Dosage in Pediatric Patients with Body Surface Area Less Than 1.0 Meter-Squared

The recommended dosage of VITRAKVI is 100 mg/m² orally twice daily, with or without food, until disease progression or until unacceptable toxicity.

2.3 Dosage Modifications for Adverse Reactions

For Grade 3 or 4 adverse reactions:

- Withhold VITRAKVI until adverse reaction resolves or improves to baseline or Grade 1. Resume at the next dosage modification if resolution occurs within 4 weeks.
- Permanently discontinue VITRAKVI if an adverse reaction does not resolve within 4 weeks.

The recommended dosage modifications for VITRAKVI for adverse reactions are provided in Table 1.

Table 1 Recommended Dosage Modifications for VITRAKVI for Adverse Reactions

Dosage Modification	Adult and Pediatric Patients with Body Surface Area of at Least 1.0 m ²	Pediatric Patients with Body Surface Area Less Than 1.0 m ²
---------------------	--	--

First	75 mg orally twice daily	75 mg/m ² orally twice daily
Second	50 mg orally twice daily	50 mg/m ² orally twice daily
Third	100 mg orally once daily	25 mg/m ² orally twice daily

Permanently discontinue VITRAKVI in patients who are unable to tolerate VITRAKVI after three dose modifications.

2.4 Dosage Modifications for Coadministration with Strong CYP3A4 Inhibitors

Avoid coadministration of strong CYP3A4 inhibitors with VITRAKVI. If coadministration of a strong CYP3A4 inhibitor cannot be avoided, reduce the VITRAKVI dose by 50%. After the inhibitor has been discontinued for 3 to 5 elimination half-lives, resume the VITRAKVI dose taken prior to initiating the CYP3A4 inhibitor [see *Drug Interactions (7.1), Clinical Pharmacology (12.3)*].

2.5 Dosage Modifications for Coadministration with Strong CYP3A4 Inducers

Avoid coadministration of strong CYP3A4 inducers with VITRAKVI. If coadministration of a strong CYP3A4 inducer cannot be avoided, double the VITRAKVI dose. After the inducer has been discontinued for 3 to 5 elimination half-lives, resume the VITRAKVI dose taken prior to initiating the CYP3A4 inducer [see *Drug Interactions (7.1), Clinical Pharmacology (12.3)*].

2.6 Dosage Modifications for Patients with Hepatic Impairment

Reduce the starting dose of VITRAKVI by 50% in patients with moderate (Child-Pugh B) to severe (Child-Pugh C) hepatic impairment [see *Use in Specific Populations (8.6), Clinical Pharmacology (12.3)*].

2.7 Administration

VITRAKVI capsule or oral solution may be used interchangeably.

Do not make up a missed dose within 6 hours of the next scheduled dose.

If vomiting occurs after taking a dose of VITRAKVI, take the next dose at the scheduled time.

Capsules

Swallow capsules whole with water. Do not chew or crush the capsules.

Oral Solution

- Store the glass bottle of VITRAKVI oral solution in the refrigerator. Discard any unused VITRAKVI oral solution remaining after 90 days of first opening the bottle.
- Prior to preparing an oral dose for administration, refer to the Instructions for Use.

3 DOSAGE FORMS AND STRENGTHS

Capsules

- 25 mg: white opaque hard gelatin capsule, size 2, with blue printing of "LOXO" and "LARO 25 mg" on body of capsules. 25 mg larotrectinib is equivalent to 30.7 mg larotrectinib sulfate.
- 100 mg: white opaque hard gelatin capsule, size 0, with blue printing of "LOXO" and "LARO 100 mg" on body of capsule. 100 mg larotrectinib is equivalent to 123 mg larotrectinib sulfate.

Oral Solution

- 20 mg/mL: clear yellow to orange solution. 20 mg/mL larotrectinib is equivalent to 24.6 mg/mL larotrectinib sulfate.

4 CONTRAINDICATIONS

None.

5 WARNINGS AND PRECAUTIONS

5.1 Neurotoxicity

Among the 176 patients who received VITRAKVI, neurologic adverse reactions of any grade occurred in 53% of patients, including Grade 3 and Grade 4 neurologic adverse reactions in 6% and 0.6% of patients, respectively [see *Adverse Reactions (6.1)*]. The majority (65%) of neurologic adverse reactions occurred within the first three months of treatment (range: 1 day to 2.2 years). Grade 3 neurologic adverse reactions included delirium (2%), dysarthria (1%), dizziness (1%), gait disturbance (1%), and paresthesia (1%). Grade 4 encephalopathy (0.6%) occurred in a single patient. Neurologic adverse reactions leading to dose modification included dizziness (3%), gait disturbance (1%), delirium (1%), memory impairment (1%), and tremor (1%).

Advise patients and caretakers of these risks with VITRAKVI. Advise patients not to drive or operate hazardous machinery if they are experiencing neurologic adverse reactions. Withhold or permanently discontinue VITRAKVI based on the severity. If withheld, modify the VITRAKVI dosage when resumed [see *Dosage and Administration (2.3)*].

5.2 Hepatotoxicity

Among the 176 patients who received VITRAKVI, increased transaminases of any grade occurred in 45%, including Grade 3 increased AST or ALT in 6% of patients [see *Adverse Reactions (6.1)*]. One patient (0.6%) experienced Grade 4 increased ALT. The median time to onset of increased AST was 2 months (range: 1 month to 2.6 years). The median time to onset of increased ALT was 2 months (range: 1 month to 1.1 years). Increased AST and ALT leading to dose modifications occurred in 4% and 6% of patients, respectively. Increased AST or ALT led to permanent discontinuation in 2% of patients.

Monitor liver tests, including ALT and AST, every 2 weeks during the first month of treatment, then monthly thereafter, and as clinically indicated. Withhold or permanently discontinue VITRAKVI based on the severity. If withheld, modify the VITRAKVI dosage when resumed [see *Dosage and Administration (2.3)*].

5.3 Embryo-Fetal Toxicity

Based on literature reports in human subjects with congenital mutations leading to changes in TRK signaling, findings from animal studies, and its mechanism of action, VITRAKVI can cause fetal harm when administered to a pregnant woman. Larotrectinib resulted in malformations in rats and rabbits at maternal exposures that were approximately 11- and 0.7-times, respectively, those observed at the clinical dose of 100 mg twice daily. Advise women of the potential risk to a fetus. Advise females of reproductive potential to use an effective method of contraception during treatment and for 1 week after the final dose of VITRAKVI [see *Use in Specific Populations (8.1, 8.3)*].

6 ADVERSE REACTIONS

The following clinically significant adverse reactions are described elsewhere in the labeling:

- Neurotoxicity [see *Warnings and Precautions (5.1)*]
- Hepatotoxicity [see *Warnings and Precautions (5.2)*]

6.1 Clinical Trial Experience

Because clinical trials are conducted under widely varying conditions, adverse reaction rates observed

in the clinical trials of a drug cannot be directly compared to rates in the clinical trials of another drug and may not reflect the rates observed in practice.

Data in WARNINGS AND PRECAUTIONS and below reflects exposure to VITRAKVI in 176 patients, including 70 (40%) patients exposed for greater than 6 months and 35 (20%) patients exposed for greater than 1 year. VITRAKVI was studied in one adult dose-finding trial [LOXO-TRK-14001 (n = 70)], one pediatric dose-finding trial [SCOUT (n = 43)], and one single arm trial [NAVIGATE (n = 63)]. All patients had an unresectable or metastatic solid tumor and no satisfactory alternative treatment options or disease progression following treatment.

Across these 176 patients, the median age was 51 years (range: 28 days to 82 years); 25% were 18 years or younger; 52% were male; and 72% were White, 11% were Hispanic/Latino, 8% were Black, and 3% were Asian. The most common tumors in order of decreasing frequency were soft tissue sarcoma (16%), salivary gland (11%), lung (10%), thyroid (9%), colon (8%), infantile fibrosarcoma (8%), primary central nervous system (CNS) (7%), or melanoma (5%). *NTRK* gene fusions were present in 60% of VITRAKVI-treated patients. Most adults (80%) received VITRAKVI 100 mg orally twice daily and 68% of pediatrics (18 years or younger) received VITRAKVI 100 mg/m² twice daily up to a maximum dose of 100 mg twice daily. The dose ranged from 50 mg daily to 200 mg twice daily in adults and 9.6 mg/m² twice daily to 120 mg/m² twice daily in pediatrics [see *Pediatric Use (8.4)*].

The most common adverse reactions (≥ 20%) in order of decreasing frequency were fatigue, nausea, dizziness, vomiting, anemia, increased AST, cough, increased ALT, constipation, and diarrhea.

The most common serious adverse reactions (≥ 2%) were pyrexia, diarrhea, sepsis, abdominal pain, dehydration, cellulitis, and vomiting. Grade 3 or 4 adverse reactions occurred in 51% of patients; adverse reactions leading to dose interruption or reduction occurred in 37% of patients and 13% permanently discontinued VITRAKVI for adverse reactions.

The most common adverse reactions (1-2% each) that resulted in discontinuation of VITRAKVI were brain edema, intestinal perforation, pericardial effusion, pleural effusion, small intestinal obstruction, dehydration, fatigue, increased ALT, increased AST, enterocutaneous fistula, increased amylase, increased lipase, muscular weakness, abdominal pain, asthenia, decreased appetite, dyspnea, hyponatremia, jaundice, syncope, vomiting, acute myeloid leukemia, and nausea.

The most common adverse reactions (≥ 3%) resulting in dose modification (interruption or reduction) were increased ALT (6%), increased AST (6%), and dizziness (3%). Most (82%) adverse reactions leading to dose modification occurred during the first three months of exposure.

Adverse reactions of VITRAKVI occurring in ≥ 10% of patients and laboratory abnormalities worsening from baseline in ≥ 5% of patients are summarized in Table 2 and Table 3, respectively.

Table 2 Adverse Reactions Occurring in ≥ 10% of Patients Treated with VITRAKVI

Adverse Reaction	VITRAKVI N = 176	
	All Grades* (%)	Grade 3-4† (%)
General		
Fatigue	37	3
Pyrexia	18	1
Edema peripheral	15	0
Gastrointestinal		
Nausea	29	1
Vomiting	26	1
Constipation	23	1
Diarrhea	22	2

Abdominal pain	13	2
Nervous System		
Dizziness	28	1
Headache	14	0
Respiratory, Thoracic and Mediastinal		
Cough	26	0
Dyspnea	18	2
Nasal congestion	10	0
Investigations		
Increased weight	15	4
Musculoskeletal and Connective Tissue		
Arthralgia	14	1
Myalgia	14	1
Muscular weakness	13	0
Back pain	12	1
Pain in extremity	12	1
Metabolism and Nutrition		
Decreased appetite	13	2
Vascular		
Hypertension	11	2
Injury, Poisoning and Procedural Complications		
Fall	10	1

* National Cancer Institute-Common Terminology Criteria for Adverse Events (NCI-CTCAE) v 4.03.

† One Grade 4 adverse reaction of pyrexia.

Table 3 Laboratory Abnormalities Occurring in $\geq 5\%$ Patients Treated with VITRAKVI

Laboratory Abnormality	VITRAKVI*	
	All Grades [†] (%)	Grade 3-4 (%)
Chemistry		
Increased ALT	45	3
Increased AST	45	3
Hypoalbuminemia	35	2
Increased alkaline phosphatase	30	3
Hematology		
Anemia	42	10
Neutropenia	23	7

* Denominator for each laboratory parameter is based on the number of patients with a baseline and post-treatment laboratory value available which ranged from 170 to 174 patients.

† NCI-CTCAE v 4.03.

7 DRUG INTERACTIONS

7.1 Effects of Other Drugs on VITRAKVI

Strong CYP3A4 Inhibitors

Coadministration of VITRAKVI with a strong CYP3A4 inhibitor may increase larotrectinib plasma concentrations, which may result in a higher incidence of adverse reactions [see *Clinical Pharmacology (12.3)*]. Avoid coadministration of VITRAKVI with strong CYP3A4 inhibitors, including grapefruit or grapefruit juice. If coadministration of strong CYP3A4 inhibitors cannot be avoided, modify VITRAKVI dose as recommended [see *Dosage and Administration (2.4)*].

Strong CYP3A4 Inducers

Coadministration of VITRAKVI with a strong CYP3A4 inducer may decrease larotrectinib plasma concentrations, which may decrease the efficacy of VITRAKVI [see *Clinical Pharmacology (12.3)*]. Avoid coadministration of VITRAKVI with strong CYP3A4 inducers, including St. John's wort. If coadministration of strong CYP3A4 inducers cannot be avoided, modify VITRAKVI dose as recommended [see *Dosage and Administration (2.5)*].

7.2 Effects of VITRAKVI on Other Drugs

Sensitive CYP3A4 Substrates

Coadministration of VITRAKVI with sensitive CYP3A4 substrates may increase their plasma concentrations, which may increase the incidence or severity of adverse reactions [see *Clinical Pharmacology (12.3)*]. Avoid coadministration of VITRAKVI with sensitive CYP3A4 substrates. If coadministration of these sensitive CYP3A4 substrates cannot be avoided, monitor patients for increased adverse reactions of these drugs.

8 USE IN SPECIFIC POPULATIONS

8.1 Pregnancy

Risk Summary

Based on literature reports in human subjects with congenital mutations leading to changes in TRK signaling, findings from animal studies, and its mechanism of action [see *Clinical Pharmacology (12.1)*], VITRAKVI can cause embryo-fetal harm when administered to a pregnant woman. There are no available data on VITRAKVI use in pregnant women. Administration of larotrectinib to pregnant rats and rabbits during the period of organogenesis resulted in malformations at maternal exposures that were approximately 11- and 0.7-times, respectively, those observed at the clinical dose of 100 mg twice daily (see *Data*). Advise pregnant women of the potential risk to a fetus.

In the U.S. general population, the estimated background risk of major birth defects and miscarriage in clinically recognized pregnancies is 2% to 4% and 15% to 20%, respectively.

Data

Human Data

Published reports of individuals with congenital mutations in TRK pathway proteins suggest that decreases in TRK-mediated signaling are correlated with obesity, developmental delays, cognitive impairment, insensitivity to pain, and anhidrosis.

Animal Data

Larotrectinib crosses the placenta in animals. Larotrectinib did not result in embryolethality at maternally toxic doses [up to 40 times the human exposure based on area under the curve (AUC) at the clinical dose of 100 mg twice daily] in embryo-fetal development studies in pregnant rats dosed during the period of organogenesis; however, larotrectinib was associated with fetal anasarca in rats from dams treated at twice-daily doses of 40 mg/kg [11 times the human exposure (AUC) at the clinical dose of 100 mg twice daily]. In pregnant rabbits, larotrectinib administration was associated with omphalocele at twice-daily doses of 15 mg/kg (0.7 times the human exposure at the clinical dose of 100 mg twice daily).

8.2 Lactation

Risk Summary

There are no data on the presence of larotrectinib or its metabolites in human milk and no data on its effects on the breastfed child or on milk production. Because of the potential for serious adverse reactions in breastfed children, advise women not to breastfeed during treatment with larotrectinib and for 1 week after the final dose.

8.3 Females and Males of Reproductive Potential

Pregnancy Testing

Verify pregnancy status in females of reproductive potential prior to initiating VITRAKVI [see *Use in Specific Populations (8.1)*].

Contraception

VITRAKVI can cause embryo-fetal harm when administered to a pregnant woman [see *Use in Specific Populations (8.1)*].

Females

Advise female patients of reproductive potential to use effective contraception during treatment with VITRAKVI and for at least 1 week after the final dose.

Males

Advise males with female partners of reproductive potential to use effective contraception during treatment with VITRAKVI and for 1 week after the final dose.

Infertility

Females

Based on histopathological findings in the reproductive tracts of female rats in a 1-month repeated-dose study, VITRAKVI may reduce fertility [See *Nonclinical Toxicology (13.1)*].

8.4 Pediatric Use

The safety and effectiveness of VITRAKVI in pediatric patients was established based upon data from three multicenter, open-label, single-arm clinical trials in adult or pediatric patients 28 days and older [see *Adverse Reactions (6.1)*, *Clinical Studies (14)*].

The efficacy of VITRAKVI was evaluated in 12 pediatric patients and is described in the Clinical Studies section [see *Clinical Studies (14)*]. The safety of VITRAKVI was evaluated in 44 pediatric patients who received VITRAKVI. Of these 44 patients, 27% were 1 month to < 2 years (n = 12), 43% were 2 years to < 12 years (n = 19), and 30% were 12 years to < 18 years (n = 13); 43% had metastatic disease and 57% had locally advanced disease; and 91% had received prior treatment for their cancer, including surgery, radiotherapy, or systemic therapy. The most common cancers were infantile fibrosarcoma (32%), soft tissue sarcoma (25%), primary CNS tumors (20%), and thyroid cancer (9%). The median duration of exposure was 5.4 months (range: 9 days to 1.9 years).

Due to the small number of pediatric and adult patients, the single arm design of clinical studies of VITRAKVI, and confounding factors such as differences in susceptibility to infections between pediatric and adult patients, it is not possible to determine whether differences in the incidence of adverse reactions to VITRAKVI are related to patient age or other factors. Adverse reactions and laboratory abnormalities of Grade 3 or 4 severity occurring more frequently (at least a 5% increase in per-patient incidence) in pediatric patients compared to adult patients were increased weight (11% vs. 2%) and neutropenia (20% vs. 2%). One of the 44 pediatric patients discontinued VITRAKVI due to an adverse reaction (Grade 3 increased ALT).

The pharmacokinetics of VITRAKVI in the pediatric population were similar to those seen in adults [see Clinical Pharmacology (12.3)].

Juvenile Animal Toxicity Data

Larotrectinib was administered in a juvenile toxicity study in rats at twice daily doses of 0.2, 2 and 7.5 mg/kg from postnatal day (PND) 7 to 27 and at twice daily doses of 0.6, 6 and 22.5mg/kg between PND 28 and 70. The dosing period was equivalent to human pediatric populations from newborn to adulthood. The doses of 2/6 mg/kg twice daily [approximately 0.7 times the human exposure (AUC) at the clinical dose of 100 mg twice daily] and 7.5/22.5 mg/kg twice daily (approximately 4 times the human exposure at the clinical dose of 100 mg twice daily) resulted in mortality between PND 9 to 99; a definitive cause of death was not identified in the majority of cases.

The main findings were transient central nervous system-related signs including head flick, tremor, and circling in both sexes. An increase in the number of errors in a maze swim test occurred in females at exposures of approximately 4 times the human exposure (AUC) at the clinical dose of 100 mg twice daily. Decreased growth and delays in sexual development occurred in the mid- and high-dose groups. Mating was normal in treated animals, but a reduction in pregnancy rate occurred at the high-dose of 7.5/22.5 mg/kg twice daily (approximately 4 times the human exposure at the clinical dose of 100 mg twice daily).

8.5 Geriatric Use

Of 176 patients in the overall safety population who received VITRAKVI, 22% of patients were \geq 65 years of age and 5% of patients were \geq 75 years of age. Clinical studies of VITRAKVI did not include sufficient numbers of subjects aged 65 and over to determine whether they respond differently from younger subjects.

8.6 Hepatic Impairment

No dose adjustment is recommended for patients with mild hepatic impairment (Child-Pugh A). Larotrectinib clearance was reduced in subjects with moderate (Child-Pugh B) to severe (Child-Pugh C) hepatic impairment [see *Clinical Pharmacology (12.3)*]. Reduce VITRAKVI dose as recommended [see *Dosage and Administration (2.6)*].

8.7 Renal Impairment

No dose adjustment is recommended for patients with renal impairment of any severity [see *Clinical Pharmacology (12.3)*].

11 DESCRIPTION

Larotrectinib is a kinase inhibitor. VITRAKVI (larotrectinib) capsules and oral solution are formulated using larotrectinib sulfate. The molecular formula for larotrectinib sulfate is $C_{21}H_{24}F_2N_6O_6S$ and the molecular weight is 526.51 g/mol for the sulfate salt and 428.44 g/mol for the free base. The chemical name is (3S)-N-{5-[(2R)-2-(2,5-difluorophenyl)-1-pyrrolidinyl]pyrazolo[1,5-a]pyrimidin-3-yl}-3-hydroxy-1-pyrrolidinecarboxamide sulfate. Larotrectinib sulfate has the following chemical structure:

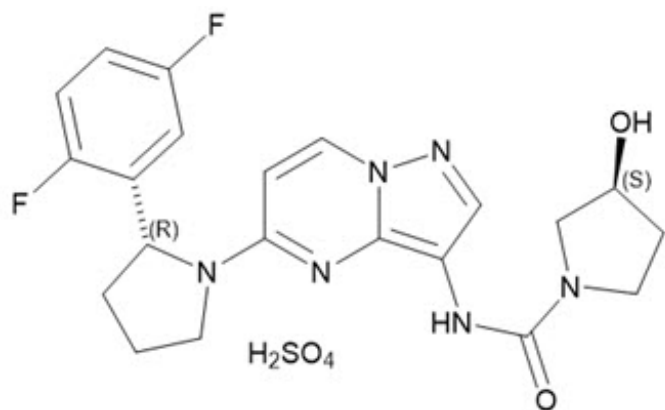

Larotrectinib sulfate is an off-white to pinkish yellow solid that is not hygroscopic. The aqueous solubility of larotrectinib at 37°C is pH dependent (very soluble at pH 1.0 and freely soluble at pH 6.8, according to USP descriptive terms of solubility).

VITRAKVI (larotrectinib) capsules and oral solution are for oral use. Each capsule contains 25 mg or 100 mg larotrectinib (30.7 mg and 123 mg larotrectinib sulfate, respectively) in a hard gelatin capsule. The capsule is composed of gelatin, titanium dioxide, and edible ink.

The oral solution contains 20 mg/mL larotrectinib (24.6 mg/mL larotrectinib sulfate) and the following inactive ingredients: purified water, hydroxypropyl betadex, sucrose, glycerin, sorbitol, citric acid, sodium phosphate, sodium citrate dihydrate, propylene glycol and flavoring. Preserved with methylparaben and potassium sorbate.

12 CLINICAL PHARMACOLOGY

12.1 Mechanism of Action

Larotrectinib is an inhibitor of the tropomyosin receptor kinases (TRK), TRKA, TRKB, and TRKC. In a broad panel of purified enzyme assays, larotrectinib inhibited TRKA, TRKB, and TRKC with IC_{50} values between 5-11 nM. One other kinase TNK2 was inhibited at approximately 100-fold higher concentration. TRKA, B, and C are encoded by the genes *NTRK1*, *NTRK2*, and *NTRK3*. Chromosomal rearrangements involving in-frame fusions of these genes with various partners can result in constitutively-activated chimeric TRK fusion proteins that can act as an oncogenic driver, promoting cell proliferation and survival in tumor cell lines.

In *in vitro* and *in vivo* tumor models, larotrectinib demonstrated anti-tumor activity in cells with constitutive activation of TRK proteins resulting from gene fusions, deletion of a protein regulatory domain, or in cells with TRK protein overexpression. Larotrectinib had minimal activity in cell lines with point mutations in the TRKA kinase domain, including the clinically identified acquired resistance mutation, G595R. Point mutations in the TRKC kinase domain with clinically identified acquired resistance to larotrectinib include G623R, G696A, and F617L.

12.2 Pharmacodynamics

Cardiac Electrophysiology

At a dose 9-fold higher than the recommended adult dose, VITRAKVI does not prolong QTc intervals to any clinically relevant extent.

12.3 Pharmacokinetics

The pharmacokinetics of larotrectinib were studied in healthy subjects and adult and pediatric patients with locally advanced or metastatic solid tumors. In healthy subjects who received a single dose of VITRAKVI capsules, systemic exposure (C_{max} and AUC) of larotrectinib was dose proportional over

the dose range of 100 mg to 400 mg (1 to 4 times the recommended adult dose) and slightly greater than proportional at doses of 600 mg to 900 mg (6 to 9 times the recommended adult dose). In adult patients who received VITRAKVI capsules 100 mg twice daily in Study LOXO-TRK-14001, peak plasma levels (C_{max}) of larotrectinib were achieved at approximately 1 hour after dosing and steady-state was reached within 3 days. Mean steady-state larotrectinib [coefficient of variation (CV%)] for C_{max} was 788 (81%) ng/mL and AUC_{0-24hr} was 4351 (97%) ng*h/mL.

Absorption

The mean absolute bioavailability of VITRAKVI capsules was 34% (range: 32% to 37%). In healthy subjects, the AUC of VITRAKVI oral solution was similar to that of the capsules and the C_{max} was 36% higher with the oral solution.

Effect of Food

The AUC of larotrectinib was similar and the C_{max} was reduced by 35% after oral administration of a single 100 mg capsule of VITRAKVI to healthy subjects taken with a high-fat meal (approximately 900 calories, 58 grams carbohydrate, 56 grams fat and 43 grams protein) compared to the C_{max} and AUC in the fasted state.

Distribution

The mean (CV%) volume of distribution (V_{ss}) of larotrectinib is 48 (38%) L following intravenous administration of larotrectinib in healthy subjects.

Larotrectinib is 70% bound to human plasma proteins in vitro and binding is independent of drug concentrations. The blood-to-plasma concentration ratio is 0.9.

Elimination

The mean (CV%) clearance (CL/F) of larotrectinib is 98 (44%) L/h and the half-life is 2.9 hours following oral administration of VITRAKVI in healthy subjects.

Metabolism

Larotrectinib is metabolized predominantly by CYP3A4. Following oral administration of a single [^{14}C] radiolabeled 100 mg dose of larotrectinib to healthy subjects, unchanged larotrectinib constituted 19% and an O-linked glucuronide constituted 26% of the major circulating radioactive drug components in plasma.

Excretion

Following oral administration of a single [^{14}C] radiolabeled 100 mg dose of larotrectinib to healthy subjects, 58% (5% unchanged) of the administered radioactivity was recovered in feces and 39% (20% unchanged) was recovered in urine.

Specific Populations

Age (range: 28 days to 82 years), sex, and body weight (range: 3.8 kg to 179 kg) had no clinically meaningful effect on the pharmacokinetics of larotrectinib.

Pediatric Patients

In pediatric patients, the larotrectinib geometric mean (%CV) AUC_{0-24hr} by age subgroup was: 3348 (66%) ng*h/mL in patients 1 month to < 2 years (n = 9), 4135 (36%) ng*h/mL in patients 2 to < 12 years (n = 15), and 3108 (69%) ng*h/mL and in patients 12 to < 18 years (n = 9).

Patients with Renal Impairment

Following oral administration of a single 100 mg dose of VITRAKVI capsules in subjects with end-stage renal disease (e.g., subjects who required dialysis), the AUC_{0-INF} of larotrectinib increased 1.5-fold and C_{max} increased 1.3-fold as compared to that in subjects with normal renal function (creatinine clearance ≥ 90 mL/min as estimated by Cockcroft-Gault). The pharmacokinetics of VITRAKVI in

patients with moderate to severe renal impairment (creatinine clearance \leq 60 mL/min) have not been studied.

Patients with Hepatic Impairment

Following oral administration of a single 100 mg dose of VITRAKVI capsules, the AUC_{0-1NF} of larotrectinib increased 1.3-fold in subjects with mild hepatic impairment (Child-Pugh A), 2-fold in subjects with moderate hepatic impairment (Child-Pugh B) and 3.2-fold in subjects with severe hepatic impairment (Child-Pugh C) as compared to that in subjects with normal hepatic function. The C_{max} was similar in subjects with mild and moderate hepatic impairment and the C_{max} of larotrectinib increased 1.5-fold in subjects with severe hepatic impairment as compared to that in subjects with normal hepatic function [see *Dosage and Administration (2.6)*, *Use in Specific Populations (8.6)*].

Drug Interaction Studies

Clinical Studies

Effect of Strong CYP3A Inhibitors: Coadministration of a single 100 mg dose of VITRAKVI capsules with a strong CYP3A inhibitor (itraconazole) increased the AUC_{0-1NF} of larotrectinib by 4.3-fold and the C_{max} by 2.8-fold as compared to VITRAKVI administered alone [see *Dosage and Administration (2.4)*, *Drug Interactions (7.1)*]. The effects of CYP3A moderate and weak inhibitors on the pharmacokinetics of larotrectinib have not been studied.

Effect of Strong CYP3A Inducers: Coadministration of a single 100 mg dose of VITRAKVI capsules with a strong CYP3A inducer (rifampin) decreased the AUC_{0-1NF} of larotrectinib by 81% and of C_{max} by 71% as compared to VITRAKVI administered alone [see *Dosage and Administration (2.5)*, *Drug Interactions (7.1)*]. The effects of CYP3A weak and moderate inducers on the pharmacokinetics of larotrectinib have not been studied.

Effect of Strong P-glycoprotein (P-gp) Inhibitors: Coadministration of a single 100 mg dose of VITRAKVI capsules with a P-gp inhibitor (rifampin) increased the AUC_{0-1NF} of larotrectinib by 1.7-fold and the C_{max} by 1.8-fold as compared to VITRAKVI administered alone.

Effect of Larotrectinib on CYP3A4 Substrates: Coadministration of VITRAKVI capsules 100 mg twice daily with a sensitive CYP3A4 substrate (midazolam) increased both the AUC_{0-1NF} and C_{max} of midazolam by 1.7-fold as compared to midazolam administered alone. The AUC_{0-1NF} and C_{max} of 1-hydroxymidazolam, the main metabolite of midazolam, were both increased 1.4-fold as compared to when midazolam was administered alone [see *Drug Interactions (7.2)*].

In Vitro Studies

Effect of Transporter on Larotrectinib: Larotrectinib is a substrate for P-gp and BCRP. Larotrectinib is not a substrate of OAT1, OAT3, OCT1, OCT2, OATP1B1, or OATP1B3.

Effect of Larotrectinib on Transporters: Larotrectinib is not an inhibitor of BCRP, P-gp, OAT1, OAT3, OCT1, OCT2, OATP1B1, OATP1B3, BSEP, MATE1 and MATE2-K at clinically relevant concentrations.

Effect of Larotrectinib on CYP Substrates: Larotrectinib is not an inhibitor or inducer of CYP1A2, CYP2B6, CYP2C8, CYP2C9, CYP2C19, or CYP2D6 at clinically relevant concentrations.

13 NONCLINICAL TOXICOLOGY

13.1 Carcinogenesis, Mutagenesis, Impairment of Fertility

Carcinogenicity studies have not been conducted with larotrectinib. Larotrectinib was not mutagenic in the in vitro bacterial reverse mutation (Ames) assays, with or without metabolic activation, or in the in vitro mammalian mutagenesis assays, with or without metabolic activation. In vivo, larotrectinib was negative in the mouse micronucleus test.

Fertility studies with larotrectinib have not been conducted. In a 3-month repeat-dose toxicity study in the rat, larotrectinib had no effects on spermatogenesis at 75 mg/kg/day (approximately 7 times the human exposure at the 100 mg twice daily dose). Additionally, larotrectinib had no histological effects on the male reproductive tract in rats or monkeys at doses resulting in exposures up to 10 times the human exposure (AUC_{0-24hr}) at the 100 mg twice daily clinical dose.

In a 1-month repeat-dose study in the rat, decreased uterine weight and uterine atrophy were seen at 200 mg/kg/day [approximately 45 times the human exposure (AUC) at the 100 mg twice daily dose]. Fewer corpora lutea and increased incidence of anestrus were also noted at doses \geq 60 mg/kg/day (approximately 10 times the human exposure at the 100 mg twice daily dose). Decreased fertility occurred in a juvenile animal study [see *Use in Specific Populations (8.4)*]. There were no findings in female reproductive organs in repeat-dose studies in monkeys at exposures up to 22 times the human exposure at the 100 mg twice daily dose.

13.2 Animal Toxicology and/or Pharmacology

In general toxicology studies conducted in rats and monkeys and in reproductive toxicology studies conducted in rats and rabbits, administration of larotrectinib led to increased food consumption and increased body weight at doses resulting in exposures 0.6 times the human exposure at the 100 mg twice daily clinical dose. Obesity has also been one phenotypic outcome of some human syndromes resulting from congenital mutations in *NTRK2* resulting in altered TRK signaling.

14 CLINICAL STUDIES

The efficacy of VITRAKVI was evaluated in pediatric and adult patients with unresectable or metastatic solid tumors with a *NTRK* gene fusion enrolled in one of three multicenter, open-label, single-arm clinical trials: Study LOXO-TRK-14001 (NCT02122913), SCOUT (NCT02637687), and NAVIGATE (NCT02576431). All patients were required to have progressed following systemic therapy for their disease, if available, or would have required surgery with significant morbidity for locally advanced disease.

Adult patients received VITRAKVI 100 mg orally twice daily and pediatric patients (18 years or younger) received VITRAKVI 100 mg/m² up to a maximum dose of 100 mg orally twice daily until unacceptable toxicity or disease progression. Identification of positive *NTRK* gene fusion status was prospectively determined in local laboratories using next generation sequencing (NGS) or fluorescence in situ hybridization (FISH). *NTRK* gene fusions were inferred in three patients with infantile fibrosarcoma who had a documented *ETV6* translocation identified by FISH. The major efficacy outcome measures were overall response rate (ORR) and duration of response (DOR), as determined by a blinded independent review committee (BIRC) according to RECIST v1.1.

The assessment of efficacy was based on the first 55 patients with solid tumors with an *NTRK* gene fusion enrolled across the three clinical trials. Baseline characteristics were: median age 45 years (range 4 months to 76 years); 22% <18 years of age, and 78% \geq 18 years of age; 53% male; 67% White; 7% Hispanic/Latino, 4% Asian, 4% Black; and ECOG performance status 0-1 (93%) or 2 (7%). Eighty-two percent of patients had metastatic disease and 18% had locally advanced, unresectable disease. Ninety-eight percent of patients had received prior treatment for their cancer, including surgery, radiotherapy, or systemic therapy. Of these, 82% (n = 45) received prior systemic therapy with a median of two prior systemic regimens and 35% (n = 19) received three or more prior systemic regimens. The most common cancers were salivary gland tumors (22%), soft tissue sarcoma (20%), infantile fibrosarcoma (13%), and thyroid cancer (9%). A total of 50 patients had *NTRK* gene fusions detected by NGS and 5 patients had *NTRK* gene fusions detected by FISH.

Efficacy results are summarized in Table 4, 5, and 6.

Table 4 Efficacy Results for Patients with Solid Tumors Harboring *NTRK* Gene Fusions

Efficacy Parameter	VITRAKVI N = 55
Overall response rate (95% CI)	75% (61%, 85%)
Complete response rate	22%
Partial response rate*	53%
Duration of response†	N = 41
Range (months)	1.6+, 33.2+
% with duration ≥ 6 months	73%
% with duration ≥ 9 months‡	63%
% with duration ≥ 12 months§	39%

+ Denotes ongoing response.

* Includes one pediatric patient with unresectable infantile fibrosarcoma who underwent resection following partial response and who remained disease-free at data cutoff.

† Median duration of response not reached at time of data cutoff.

‡ 3 patients with an ongoing response were followed < 9 months from onset of response.

§ 10 patients with an ongoing response were followed < 12 months from onset of response.

Table 5 Efficacy Results by Tumor Type

Tumor Type	Patients (N=55)	ORR		DOR
		%	95% CI	Range (months)
Soft tissue sarcoma	11	91%	(59%, 100%)	3.6, 33.2+
Salivary gland	12	83%	(52%, 98%)	7.7, 27.9+
Infantile fibrosarcoma	7	100%	(59%, 100%)	1.4+, 10.2+
Thyroid	5	100%	(48%, 100%)	3.7, 27.0+
Lung	4	75%	(19%, 99%)	8.2, 20.3+
Melanoma	4	50%	NA	1.9, 17.5+*
Colon	4	25%	NA	5.6*
Gastrointestinal stromal tumor	3	100%	(29%, 100%)	9.5, 17.3
Cholangiocarcinoma	2	SD, NE	NA	NA
Appendix	1	SD	NA	NA
Breast	1	PD	NA	NA
Pancreas	1	SD	NA	NA

NA = not applicable due to small numbers or lack of response; CR = complete response; PR = partial response; NE = not evaluable; SD = stable disease; PD = progressive disease.

+ Denotes ongoing response.

* Observed values at data cutoff, not a range.

Table 6 Efficacy Results by NTRK Fusion Partner

NTRK Partner*	Patients (N=55)	ORR		DOR
		%	95% CI	Range (months)
ETV6-NTRK3	25	84%	(64%, 96%)	3.7, 27.9+
TPM3-NTRK1	9	56%	(21%, 86%)	3.7, 10.3+
LMNA-NTRK1	5	40%	NA	5.6, 33.2+

Inferred ETV6-NTRK3	3	100%	(29%, 100%)	1.4+, 2.7 [†]
IRF2BP2-NTRK1	2	CR, PR	NA	3.7, 20.3+
SQSTM1-NTRK1	2	PR, PR	NA	9.9, 12.9+
PDE4DIP-NTRK1	1	PR	NA	3.6+ ‡
PPL-NTRK1	1	CR	NA	12.0+ ‡
STRN-NTRK2	1	PR	NA	5.6‡
TPM4-NTRK3	1	CR	NA	23.6‡
TPR-NTRK1	1	PR	NA	8.2‡
TRIM63-NTRK1	1	PR	NA	1.9+ ‡
CTRC-NTRK1	1	SD	NA	NA
GON4L-NTRK1	1	NE	NA	NA
PLEKHA6-NTRK1	1	SD	NA	NA

CR = complete response; PR = partial response; NE = not evaluable; SD = stable disease; NA = not applicable.

+ Denotes ongoing response.

* Fusion partners identified in the primary analysis set (N=55) may not represent all potential fusion partners.

† Duration of response censored at the time of surgery for one pediatric patient with unresectable infantile fibrosarcoma who underwent resection following partial response and who remained disease-free at data cutoff.

‡ Observed values at data cutoff, not a range.

16 HOW SUPPLIED/STORAGE AND HANDLING

Capsules

25 mg: Hard gelatin opaque white capsule size #2 with blue printing of "LOXO" and "LARO 25 mg" on the body of the capsule.

- 60 count bottle NDC# 71777-390-01

100 mg: Hard gelatin opaque white capsule size #0 with blue printing of "LOXO" and "LARO 100 mg" on the body of the capsule.

- 60 count bottle NDC# 71777-391-01

Store capsules at room temperature 20°C to 25°C (68°F to 77°F); temperature excursions between 15°C and 30°C (59°F to 86°F) are permitted [see USP Controlled Room Temperature].

Oral Solution

20 mg/mL: Clear yellow to orange solution.

- 100 mL bottle NDC# 71777-392-01

Refrigerate oral solution at 2°C to 8°C (36°F to 46°F). Do not freeze.

17 PATIENT COUNSELING INFORMATION

Advise the patient to read the FDA-approved patient labeling (Patient Information and Instructions for Use).

Neurotoxicity

Advise patients to notify their healthcare provider if they experience new or worsening neurotoxicity.

Advise patients not to drive or operate hazardous machinery if they are experiencing neurologic adverse reactions [see *Warnings and Precautions (5.1)*].

Hepatotoxicity

Advise patients that they will need to undergo laboratory tests to monitor liver function [see *Warnings and Precautions (5.2)*].

Embryo-Fetal Toxicity

Advise males and females of reproductive potential of the potential risk to a fetus [see *Warnings and Precautions (5.3), Use in Specific Populations (8.1)*].

Advise females of reproductive potential to inform their healthcare provider of a known or suspected pregnancy and to use effective contraception during the treatment with VITRAKVI and for at least 1 week after the final dose [see *Use in Specific Populations (8.3)*].

Advise males with female partners of reproductive potential to use effective contraception during treatment with VITRAKVI and for at least 1 week after the final dose [see *Use in Specific Populations (8.3)*].

Lactation

Advise women not to breastfeed during treatment with VITRAKVI and for 1 week following the final dose [see *Use in Specific Populations (8.2)*].

Infertility

Advise females of reproductive potential that VITRAKVI may impair fertility [See *Nonclinical Toxicology (13.1)*].

Drug Interactions

Advise patients and caregivers to inform their healthcare provider of all concomitant medications, including prescription medicines, over-the-counter drugs, vitamins, and herbal products. Inform patients to avoid St. John's wort, grapefruit or grapefruit juice while taking VITRAKVI [see *Drug Interactions (7.1, 7.2)*].

Manufactured for:

Loxo Oncology, Inc.
Stamford, CT 06901

PATIENT INFORMATION

VITRAKVI (vi trak vee)
(larotrectinib)
capsules and oral solution

What is VITRAKVI?

VITRAKVI is a prescription medicine that is used to treat adults and children with solid tumors (cancer) that:

- are caused by certain abnormal NTRK genes **and**
- have spread or if surgery to remove their cancer is likely to cause severe complications, **and**
- there is no acceptable treatment option **or** the cancer grew or spread on other treatment.

Your healthcare provider will perform a test to make sure that VITRAKVI is right for you. It is not known if VITRAKVI is safe and effective in children younger than 1 month of age.

Before taking VITRAKVI, tell your healthcare provider about all of your medical conditions, including if you:

- have liver problems
- have nervous system (neurological) problems
- are pregnant or plan to become pregnant. VITRAKVI can harm your unborn baby. You should not become pregnant during treatment with VITRAKVI.
 - If you are able to become pregnant, your healthcare provider may do a pregnancy test before you start treatment with VITRAKVI.
 - **Females who are able to become pregnant** should use effective birth control (contraception) during treatment and for at least **1 week** after the final dose of VITRAKVI. Talk to your healthcare provider about birth control methods that may be right for you.
 - **Males with female partners who are able to become pregnant** should use effective birth control during treatment with VITRAKVI and for at least **1 week** after the final dose of VITRAKVI.
- are breastfeeding or plan to breastfeed. It is not known if VITRAKVI passes into your breast milk. Do not breastfeed during treatment and for 1 week after the last dose of VITRAKVI.

Tell your healthcare provider about all the medicines you take, including prescription and over-the-counter medicines, vitamins, and herbal supplements. Certain other medicines may affect how VITRAKVI works. Know the medicines you take. Keep a list of them to show your healthcare provider and pharmacist when you get a new medicine.

How should I take VITRAKVI?

- Take VITRAKVI exactly as your healthcare provider tells you.
- Your healthcare provider may stop treatment or change your dose of VITRAKVI if you have side effects. Do not change your dose or stop taking VITRAKVI unless your healthcare provider tells you.
- VITRAKVI comes in capsules and as an oral solution.
- If your healthcare provider prescribes VITRAKVI oral solution:
 - Your healthcare provider will provide you with the VITRAKVI oral solution and oral syringes or send you to a pharmacy that can provide you with VITRAKVI oral solution and oral syringes.
 - Your healthcare provider should show you how to correctly measure and give a dose of VITRAKVI oral solution.
 - See the detailed Instructions for Use that comes with VITRAKVI oral solution for information about the correct way to measure and give a dose of VITRAKVI oral solution. If you have any questions, talk to your healthcare provider or pharmacist.
- VITRAKVI is usually taken by mouth 2 times a day.
- Swallow VITRAKVI capsules whole. Do not chew or crush the capsules.
- Take VITRAKVI with or without food.
- If you vomit after taking a dose of VITRAKVI, wait and take the next dose at your scheduled time
- If you miss a dose of VITRAKVI, take it as soon as you remember unless your next scheduled dose is due within 6 hours. Take the next dose at your regular time.

If you take too much VITRAKVI, call your healthcare provider.

What should I avoid while taking VITRAKVI?

- VITRAKVI can make you feel dizzy. Do not drive or operate machinery until you know how

VITRAKVI affects you.

- Avoid taking St. John's wort, eating grapefruit, or drinking grapefruit juice during treatment with VITRAKVI.

What are the possible side effects of VITRAKVI?

VITRAKVI may cause serious side effects, including:

- **Nervous system problems.** Tell your healthcare provider if you develop any symptoms such as confusion, difficulty speaking, dizziness, coordination problems, tingling, numbness, or burning sensation in your hands and feet. Your healthcare provider may temporarily stop treatment, decrease your dose, or permanently stop VITRAKVI if you develop symptoms of a nervous system problem with VITRAKVI.
- **Liver problems.** Your healthcare provider will do blood tests to check your liver function during treatment with VITRAKVI. Tell your healthcare provider right away if you develop symptoms of liver problems including: loss of appetite, nausea or vomiting, or pain on the upper right side of your stomach area. Your healthcare provider may temporarily stop treatment, decrease your dose, or permanently stop VITRAKVI if you develop liver problems with VITRAKVI.

The most common side effects of VITRAKVI include:

- tiredness
- nausea
- dizziness
- vomiting
- cough
- constipation
- diarrhea

VITRAKVI may affect fertility in females and may affect your ability to become pregnant. Talk to your healthcare provider if this is a concern for you.

These are not all the possible side effects with VITRAKVI. Call your healthcare provider for medical advice about side effects. You may report side effects to FDA at 1-800-FDA-1088.

How should I store VITRAKVI?

- Store VITRAKVI capsules at room temperature between 68°F to 77°F (20°C to 25°C).
- Store VITRAKVI oral solution in the refrigerator between 36° F to 46° F (2° C to 8° C). Do not freeze.
- Throw away (dispose of) any unused VITRAKVI oral solution remaining after 90 days of first opening the bottle.

Keep VITRAKVI and all medicines out of the reach of children.

General information about the safe and effective use of VITRAKVI.

Medicines are sometimes prescribed for purposes other than those listed in a Patient Information leaflet. Do not use VITRAKVI for a condition for which it was not prescribed. Do not give VITRAKVI to other people, even if they have the same symptoms you have. It may harm them. You can ask your healthcare provider or pharmacist for more information about VITRAKVI that is written for health professionals.

What are the ingredients in VITRAKVI?

Active ingredient: larotrectinib

Inactive ingredients:

Capsule: gelatin, titanium dioxide and edible ink

Oral Solution: purified water, hydroxypropyl betadex, sucrose, glycerin, sorbitol, citric acid, sodium phosphate, sodium citrate dihydrate, propylene glycol and flavoring. Preserved with methylparaben and potassium sorbate.

Manufactured for: Loxo Oncology, Inc., Stamford, CT 06901

For more information, go to www.VITRAKVI.com or call 1-888-842-2937

This Patient Information has been approved by the U.S. Food and Drug Administration Issued: 11/2018

Administration

INSTRUCTIONS FOR USE
VITRAKVI (vi trak vee)
(larotrectinib)
oral solution

Read this Instructions for Use before you take or give a dose of VITRAKVI oral solution for the first time and each time you get a refill. There may be new information. This information does not take the place of talking with your healthcare provider about your medical condition or your treatment. Your healthcare provider should show you how to correctly measure the prescribed dose of VITRAKVI oral solution before you take or give a dose for the first time.

Important information about measuring VITRAKVI oral solution:

- Always use the oral syringes provided with VITRAKVI to make sure that you correctly measure the prescribed dose.
- When you receive VITRAKVI oral solution from your healthcare provider or pharmacist, you will get a box that contains 1 glass bottle of VITRAKVI oral solution and a bottle adaptor. You may receive more than 1 box of VITRAKVI oral solution.
- You will receive five 1 mL or 5 mL oral syringes that are marked to help you correctly measure the prescribed dose of VITRAKVI oral solution. Each oral syringe may be used over a 7-day period. **Do not** use a household teaspoon to measure the dose.

Supplies needed to take or give a dose of VITRAKVI oral solution

Figure A

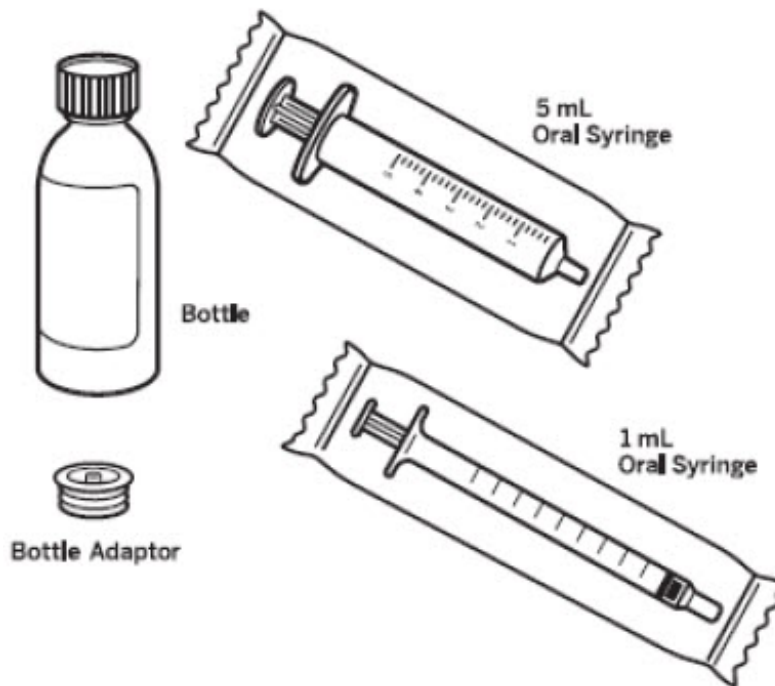

How to prepare a dose of VITRAKVI oral solution:

Step 1: Remove the VITRAKVI oral solution bottle from the box. Place the bottle on a flat work surface. Open the bottle by pushing down firmly on the child-resistant cap and turning it in the direction of the arrow (counter-clockwise) **See Figure B. Do not** throw away the child-resistant cap.

Figure B



Step 2: Insert the bottle adaptor by pressing it into the bottle neck and make sure it is secure. **See Figure C.** Do not remove the bottle adaptor. If the bottle adaptor is missing, talk to your healthcare provider.

Figure C

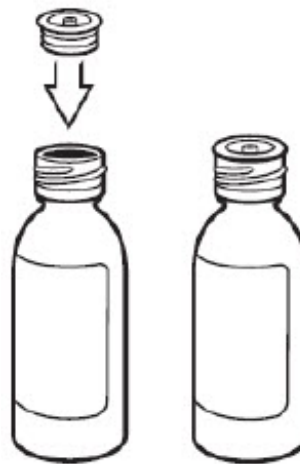

Step 3: Remove the oral syringe from the wrapper. Throw the wrapper away in your household trash. The barrel of the oral syringe has markings in milliliters (mL). Look at the markings on the barrel of the oral syringe and find the mL marking that matches the VITRAKVI oral solution dose in mL prescribed by your healthcare provider. **See Figure D.**

Figure D

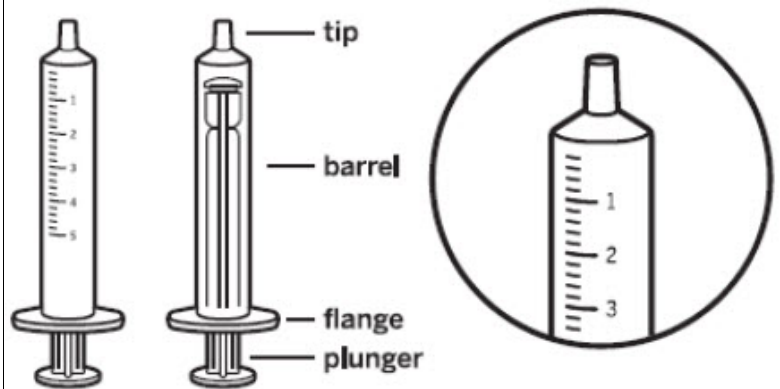

Step 4: With the bottle on your flat work surface, use 1 hand to hold the bottle upright. Using your other hand, push the air out of the oral syringe by pushing the plunger down. Then, insert the tip of the oral syringe into the bottle adaptor at the top of the bottle. **See Figure E.** The tip of the oral syringe should fit snugly into the hole of the bottle adaptor.

Figure E

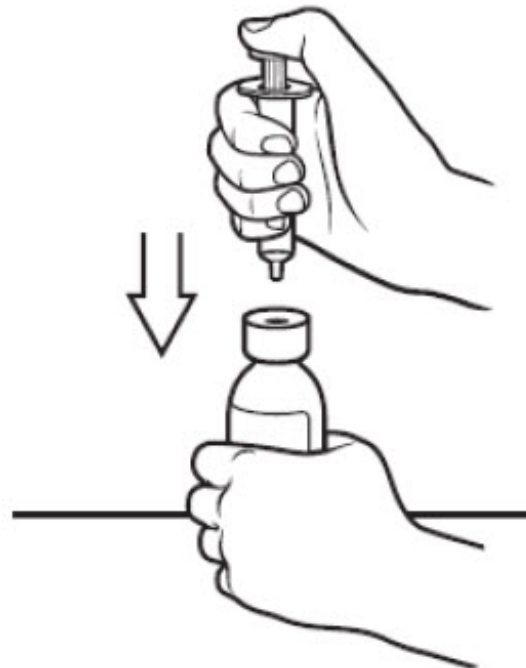

Step 5: Use 1 hand to hold the oral syringe in place. With the other hand, turn the bottle upside down. Pull back on the plunger until the top of the plunger lines up with the marking on the barrel of the oral syringe that matches the dose of VITRAKVI oral solution prescribed by your healthcare provider. See **Figure "F"**. Your dose may be different than the dose shown in Figure F.

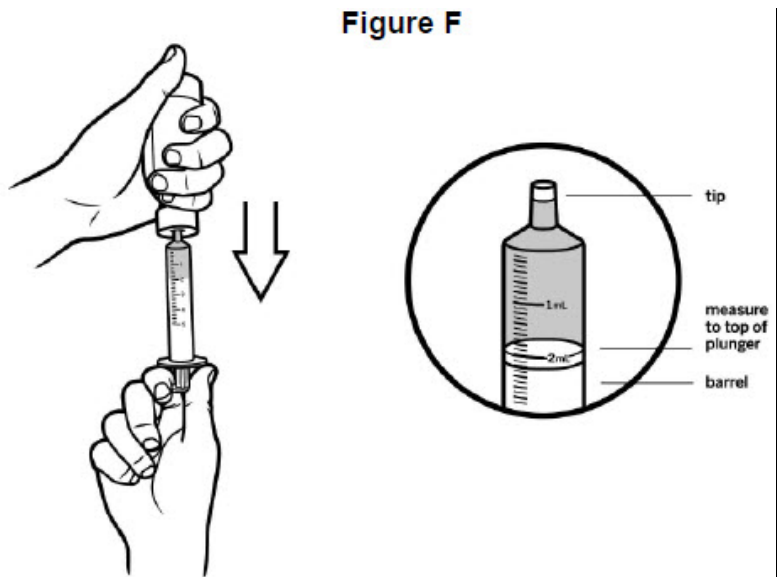

Step 6: Check for air bubbles in the oral syringe. If you see air bubbles, push up gently on the plunger to push any large air bubbles back into the bottle. Then, pull back on the plunger to the prescribed dose. See **Figure G**.

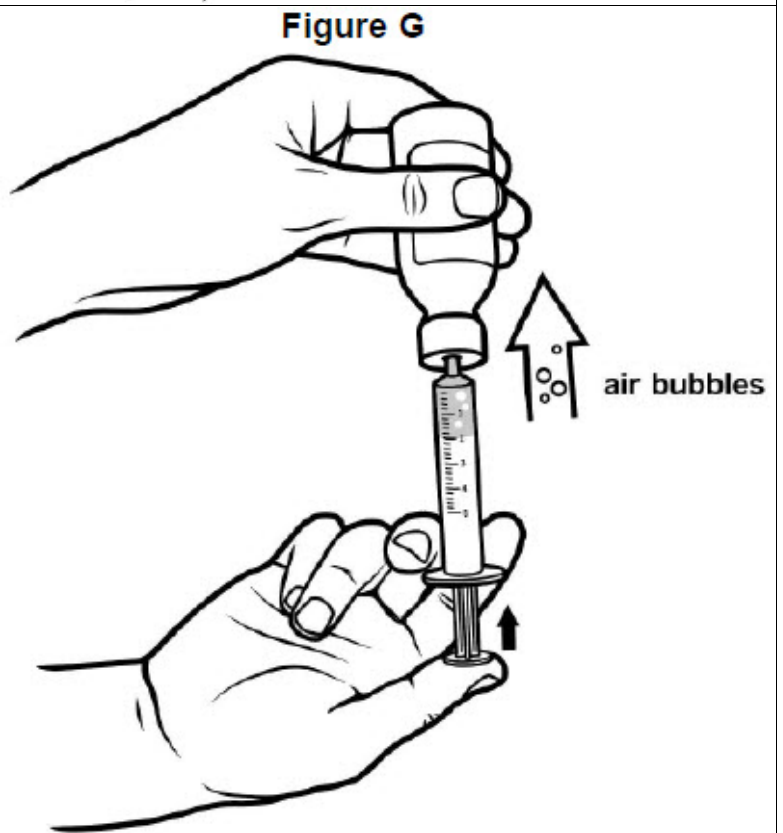

Step 7: Turn the bottle upright again and place it on your work surface. Remove the oral syringe from the bottle adaptor by gently pulling up on the syringe barrel. **See Figure H. Do not** push on the plunger during this step. The bottle adaptor should stay attached to the bottle.

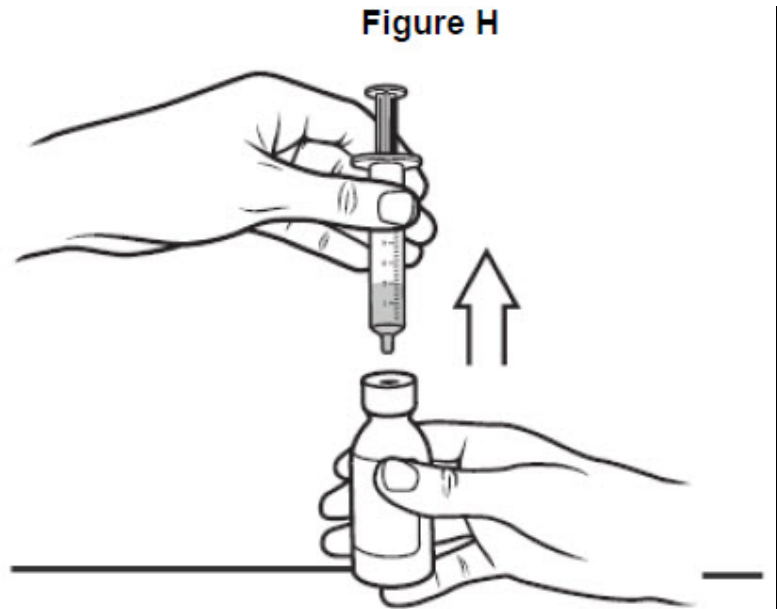

Giving a dose of VITRAKVI oral solution by mouth:

Step 8: Place the tip of the oral syringe into the child's mouth against the inside of the cheek. Slowly squirt VITRAKVI oral solution into the mouth by pressing down on the plunger and allow the child to swallow. **See Figure I.**

- The child should be kept in an upright position for a few minutes right after giving a dose of VITRAKVI.
- If the child spits up a dose or you are not sure the entire dose was given, do not give another dose. Wait until the next scheduled dose.

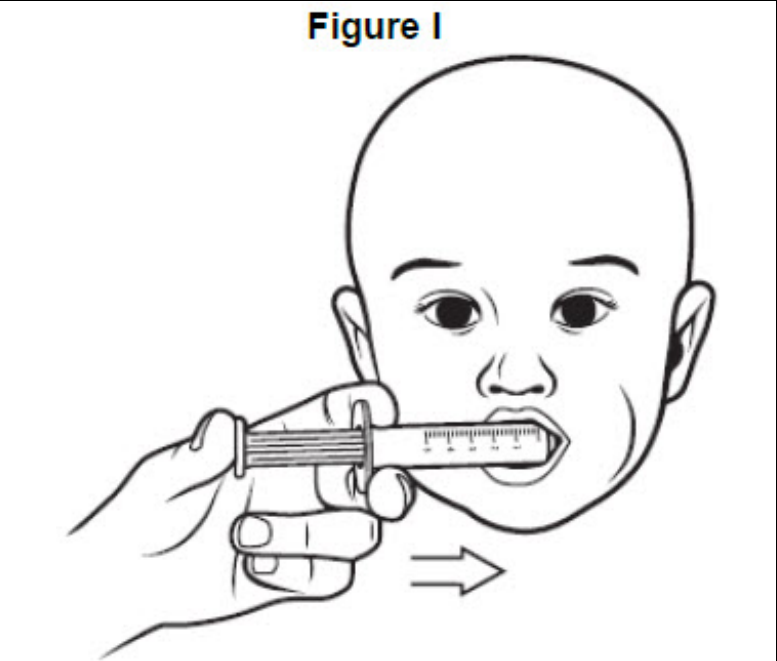

Step 9: Replace the child-resistant cap on the bottle of VITRAKVI oral solution. **Do not** remove the bottle adaptor. Close the bottle by turning the bottle cap in the direction of the arrow (clockwise). **See Figure J.**

Figure J

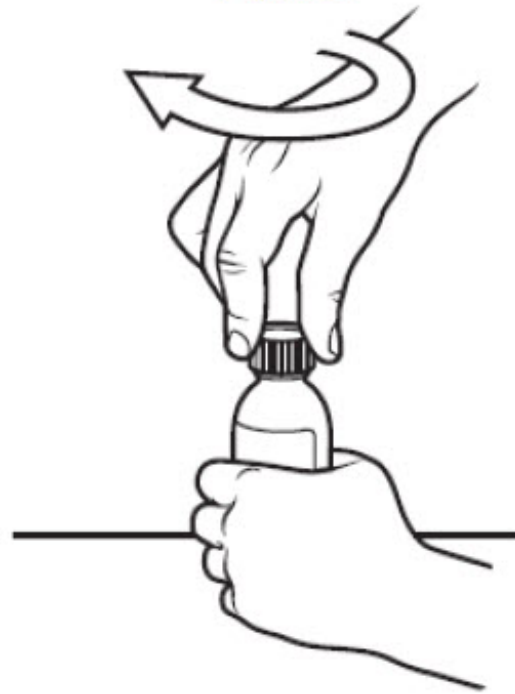

Cleaning instructions for oral syringes

Follow the instructions below for cleaning the oral syringe (Step 10 through Step 16). After 7 days of use, throw away the oral syringe in your household trash. Use a new one for the next 7 days.

Step 10: Remove plunger from the barrel of the oral syringe. **See Figure K.**

Figure K

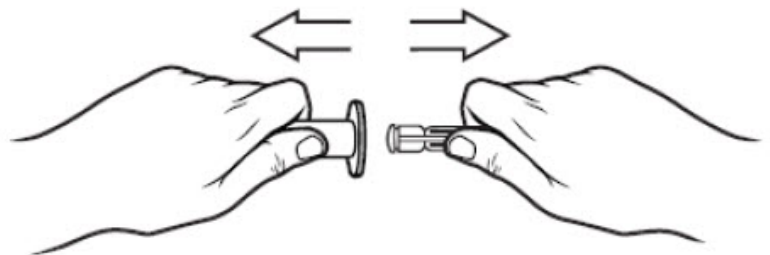

Step 11: Rinse the barrel and plunger in warm running water to help ensure that all of the medicine has been removed from the oral syringe. **See Figure L.**
Do not boil the oral syringe.

Figure L



Step 12: Re-insert the plunger into the barrel of the oral syringe. **See Figure M.**

Figure M

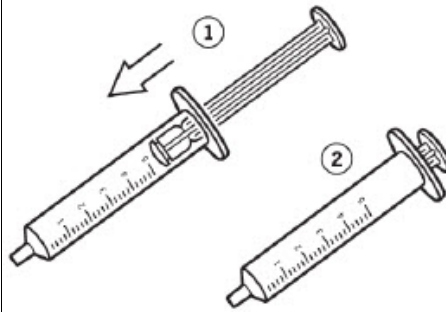

Step 13: Draw warm water several times into the oral syringe and squirt out again until all of the medicine has been removed from the oral syringe. **See Figure N.**

Figure N

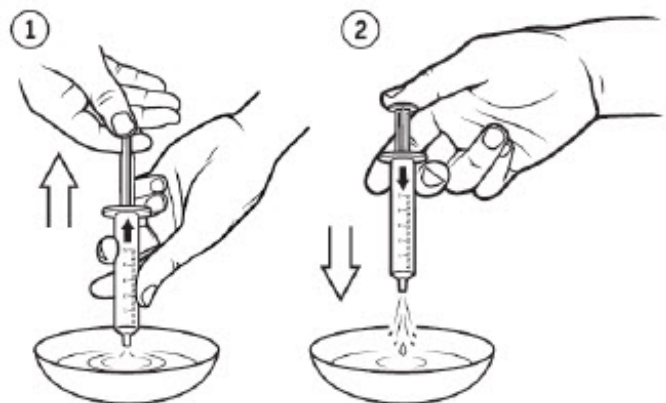

Step 14: Disassemble the oral syringe, and rinse the barrel and plunger again with warm water. See **Figure O**.

Figure O



Step 15: Shake off excess water or wipe off the outside, and then place the barrel and plunger on a clean, dry paper towel to dry. See **Figure P**.

Figure P

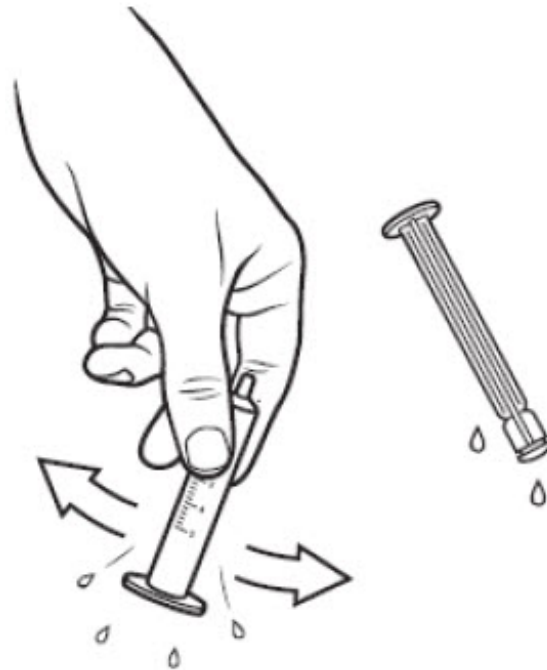

Step 16: Assemble the oral syringe and store in a clean place until the next use. Replace the oral syringe after 7 days of use, or if:

- there is any damage to the barrel, plunger, or tip
- the dosage marking is no longer clearly recognizable or
- it becomes difficult to move the plunger

How should I store VITRAKVI oral solution?

- Store VITRAKI oral solution in a refrigerator between 36° F to 46° F (2° C to 8° C). **Do not** freeze.
- Throw away any unused medicine 90 days after the date of first opening. Write the date that you opened the bottle of VITRAKVI oral solution on the bottle. **See Figure Q.**

Keep VITRAKVI oral solution and all medicines out of the reach of children.

Figure Q



Talk to your healthcare provider if you have questions about how to use VITRAKVI oral solution. For more information, go to www.VITRAKVI.com or call 1-888-842-2937.

This Instructions for Use has been approved by the U.S. Food and Drug Administration.

Manufactured for: Loxo Oncology, Inc., Stamford, CT 06901

Issued: November 2018

Package Label - Carton - 25 mg - 60 Capsules

PRINCIPAL DISPLAY PANEL

VITRAKVI®

(larotrectinib) capsules

25 mg

Each capsule contains 25 mg larotrectinib
(equivalent to 30.7 mg larotrectinib sulfate).

-60 capsules

-oral use

 **VITRAKVI®**
(larotrectinib) capsules
25 mg

Each capsule contains 25 mg larotrectinib
(equivalent to 30.7 mg larotrectinib sulfate).

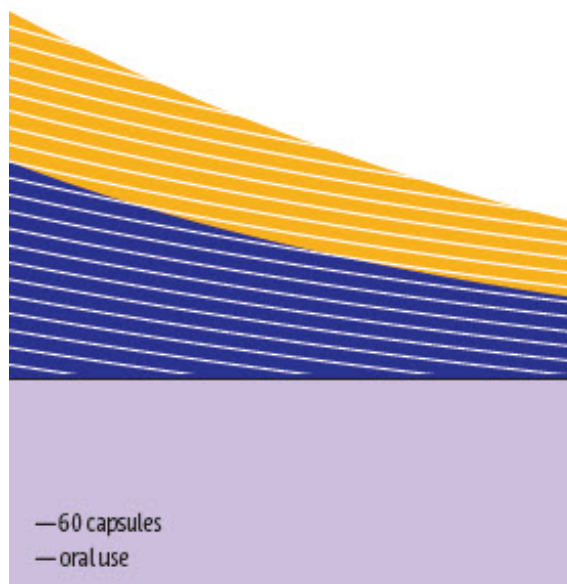

Package Label - 25 mg - 60 Capsules

PRINCIPAL DISPLAY PANEL

NDC 71777-**390**-01

VITRAKVI®

(larotrectinib) capsules

25 mg

Usual Dosage: See prescribing information. Rx **only**.

60 capsules. **Keep out of reach of children.**

Store at 20°C to 25°C (68°F to 77°F).

Excursions permitted from 15°C to 30°C (59° to 86°F).

Manufactured for Loxo Oncology, Inc. Stamford, CT 06901 86579626

(01)10371777390012

Bayer

LOXO

Each capsule contains

25 mg larotrectinib
(equivalent to 30.7 mg
larotrectinib sulfate).



Package Label - Carton - 100 mg - 60 Capsules

PRINCIPAL DISPLAY PANEL

VITRAKVI®

(larotrectinib) capsules

100 mg

Each capsule contains 100 mg larotrectinib
(equivalent to 123 mg larotrectinib sulfate).

-60 capsules

-oral use

 **VITRAKVI®**
(larotrectinib) capsules
100 mg

Each capsule contains 100 mg larotrectinib
(equivalent to 123 mg larotrectinib sulfate).

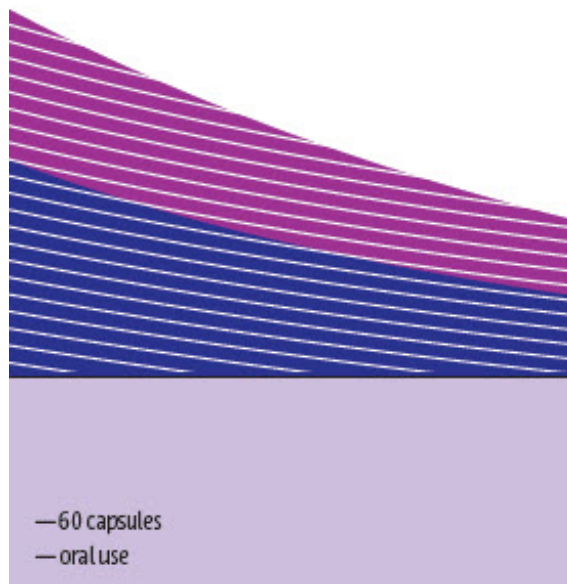

Package Label - 100 mg - 60 Capsules

PRINCIPAL DISPLAY PANEL

NDC 71777-391-01

VITRAKVI®

(larotrectinib) capsules

100 mg

Usual Dosage: See prescribing information.

Rx **only**. 60 capsules. **Keep out of reach of children.**

Store at 20°C to 25°C (68°F to 77°F).

Excursions permitted from 15°C to 30°C (59° to 86°F).

Manufactured for Loxo Oncology, Inc. Stamford, CT 06901 86579634

(01)10371777391019

Bayer

LOXO

Each capsule

contains 100 mg
larotrectinib
(equivalent to
123 mg
larotrectinib
sulfate).

NDC 71777-391-01

 **VITRAKVI[®]**
(larotrectinib) capsules
100 mg

Usual Dosage: See prescribing information.
Rx only. 60 capsules. **Keep out of reach of children.**
Store at 20°C to 25°C (68°F to 77°F).
Excursions permitted from 15°C to 30°C (59°F to 86°F).
Manufactured for Loxo Oncology, Inc., Stamford, CT 06901

86579634

 (01)1037177391019



Each capsule contains 100 mg larotrectinib (equivalent to 123 mg larotrectinib sulfate).



Package Label - Carton - 20 mg/mL - 100 mL Oral Solution

PRINCIPAL DISPLAY PANEL

VITRAKVI[®]

(larotrectinib) oral solution

20 mg/mL

Each bottle contains 100 mL of 20 mg/mL
larotrectinib (equivalent to 24.6 mg/mL
larotrectinib sulfate).

-100 mL oral solution

-oral use

 **VITRAKVI®**

(larotrectinib) oral solution

20 mg/mL

Each bottle contains 100 mL of 20 mg/mL
larotrectinib (equivalent to 24.6 mg/mL
larotrectinib sulfate).

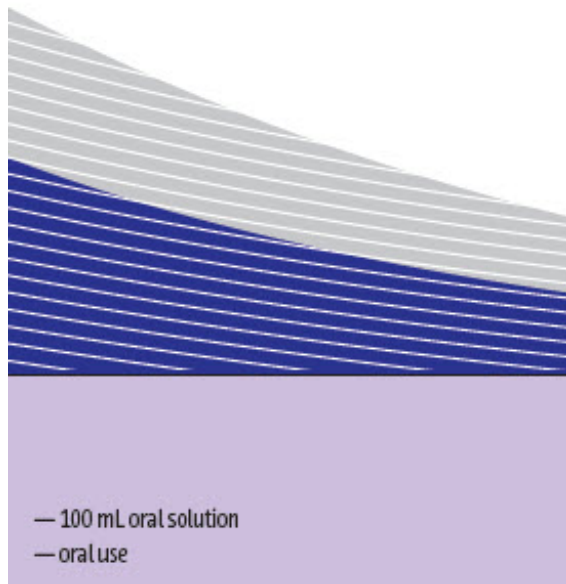

Package Label - 20 mg/mL - 100 mL Oral Solution

PRINCIPAL DISPLAY PANEL

NDC 71777-392-01

VITRAKVI®

(larotrectinib) oral solution

20 mg/mL

Usual Dosage: See prescribing information. **Keep refrigerated. Store at 2°C to 8°C (36°F to 46°F).**
Rx only.

Date of first opening ____/____/____. **Discard unused portion 90 days after first opening.**
100 mL oral solution. **Keep out of reach of children.**

Manufactured for Loxo Oncology, Inc. Stamford, CT 06901 86659069

(01)10371777392016

Bayer

LOXO

Each bottle contains

100 ml of 20 mg/mL
 larotrectinib (equivalent
 to 24.6 mg/mL
 larotrectinib sulfate).



VITRAKVI

larotrectinib capsule

Product Information

Product Type	HUMAN PRESCRIPTION DRUG	Item Code (Source)	NDC:71777-390
Route of Administration	ORAL		

Active Ingredient/Active Moiety

Ingredient Name	Basis of Strength	Strength
LAROTRECTINIB (UNII: PF9462I9HX) (LAROTRECTINIB - UNII:PF9462I9HX)	LAROTRECTINIB	25 mg

Inactive Ingredients

Ingredient Name	Strength
GELATIN, UNSPECIFIED (UNII: 2G86QN327L)	
TITANIUM DIOXIDE (UNII: 15FIX9V2JP)	

Product Characteristics

Color	WHITE (Opaque White)	Score	no score
Shape	CAPSULE	Size	18 mm
Flavor		Imprint Code	LOXO;LARO;25mg
Contains			

Packaging

#	Item Code	Package Description	Marketing Start Date	Marketing End Date
1	NDC:71777-390-01	60 in 1 BOTTLE; Type 0: Not a Combination Product	11/26/2018	

Marketing Information

Marketing Category	Application Number or Monograph Citation	Marketing Start Date	Marketing End Date
NDA	NDA210861	11/26/2018	

VITRAKVI

larotrectinib capsule

Product Information

Product Type	HUMAN PRESCRIPTION DRUG	Item Code (Source)	NDC:71777-391
Route of Administration	ORAL		

Active Ingredient/Active Moiety

Ingredient Name	Basis of Strength	Strength
LAROTRECTINIB (UNII: PF9462I9HX) (LAROTRECTINIB - UNII:PF9462I9HX)	LAROTRECTINIB	100 mg

Inactive Ingredients

Ingredient Name	Strength
GELATIN, UNSPECIFIED (UNII: 2G86QN327L)	
TITANIUM DIOXIDE (UNII: 15FIX9V2JP)	

Product Characteristics

Color	WHITE (Opaque White)	Score	no score
Shape	CAPSULE	Size	22mm
Flavor		Imprint Code	LOXO;LARO;100mg
Contains			

Packaging

#	Item Code	Package Description	Marketing Start Date	Marketing End Date
1	NDC:71777-391-01	60 in 1 BOTTLE; Type 0: Not a Combination Product	11/26/2018	

Marketing Information

Marketing Category	Application Number or Monograph Citation	Marketing Start Date	Marketing End Date
NDA	NDA210861	11/26/2018	

VITRAKVI

larotrectinib solution

Product Information

Product Type	HUMAN PRESCRIPTION DRUG	Item Code (Source)	NDC:71777-392
--------------	-------------------------	--------------------	---------------

Route of Administration ORAL

Active Ingredient/Active Moiety

Ingredient Name	Basis of Strength	Strength
LAROTRECTINIB (UNII: PF9462I9HX) (LAROTRECTINIB - UNII:PF9462I9HX)	LAROTRECTINIB	20 mg in 1 mL

Inactive Ingredients

Ingredient Name	Strength
WATER (UNII: 059QF0K00R)	
HYDROXYPROPYL BETADEX (0.6 HYDROXYPROPYL RESIDUES PER GLUCOSE) (UNII: 8W6Q67R6NX)	
SUCROSE (UNII: C151H8M554)	
GLYCERIN (UNII: PDC6A3C0OX)	
SORBITOL (UNII: 506T60A25R)	
CITRIC ACID MONOHYDRATE (UNII: 2968PHW8QP)	
SODIUM PHOSPHATE (UNII: SE337SVY37)	
TRISODIUM CITRATE DIHYDRATE (UNII: B22547B95K)	
PROPYLENE GLYCOL (UNII: 6DC9Q167V3)	
METHYLPARABEN (UNII: A2I8C7HI9T)	
POTASSIUM SORBATE (UNII: 1VPU26JZZ4)	

Product Characteristics

Color	YELLOW (Clear Yellow to Orange)	Score	
Shape		Size	
Flavor	BERRY (Citrus Berry)	Imprint Code	
Contains			

Packaging

#	Item Code	Package Description	Marketing Start Date	Marketing End Date
1	NDC:71777-392-01	100 mL in 1 BOTTLE; Type 0: Not a Combination Product	11/26/2018	

Marketing Information

Marketing Category	Application Number or Monograph Citation	Marketing Start Date	Marketing End Date
NDA	NDA211710	11/26/2018	

Labeler - Loxo Oncology, Inc. (042572897)

Registrant - Loxo Oncology, Inc. (042572897)

Establishment

Name	Address	ID/FEI	Business Operations
Penn Pharmaceutical Services Ltd		226277259	MANUFACTURE(71777-390, 71777-391, 71777-392)

Establishment

Name	Address	ID/FEI	Business Operations
Albemarle Corporation		788779192	API MANUFACTURE(71777-392)

Establishment

Name	Address	ID/FEI	Business Operations
Sharp Corporation		143696495	PACK(71777-390, 71777-391, 71777-392) , LABEL(71777-390, 71777-391, 71777-392)

Revised: 12/2018

Loxo Oncology, Inc.