

SEMGLEE- insulin glargine-yfgn injection, solution

Biocon Biologics Inc.

HIGHLIGHTS OF PRESCRIBING INFORMATION

These highlights do not include all the information needed to use SEMGLEE safely and effectively. See full prescribing information for SEMGLEE.

SEMGLEE® (insulin glargine-yfgn) injection, for subcutaneous use

Initial U.S. Approval: 2021

SEMGLEE® (insulin glargine-yfgn) is interchangeable* with LANTUS (insulin glargine).

INDICATIONS AND USAGE

SEMGLEE is a long-acting human insulin analog indicated to improve glycemic control in adult and pediatric patients with diabetes mellitus. (1)

Limitations of Use

Not recommended for the treatment of diabetic ketoacidosis. (1)

DOSAGE AND ADMINISTRATION

- Individualize dosage based on metabolic needs, blood glucose monitoring, glycemic control, type of diabetes, and prior insulin use. (2.1, 2.2, 2.3, 2.4)
- Administer subcutaneously into the abdominal area, thigh, or deltoid once daily at any time of day, but at the same time every day. (2.1)
- Do not dilute or mix with any other insulin or solution. (2.1)
- Rotate injection sites to reduce risk of lipodystrophy and localized cutaneous amyloidosis. (2.1)
- See Full Prescribing Information for the recommended starting dosage in patients with type 2 diabetes and how to change to SEMGLEE from other insulins. (2.3, 2.4)
- Closely monitor glucose when switching to SEMGLEE and during initial weeks thereafter. (2.4)

DOSAGE FORMS AND STRENGTHS

Injection: 100 units/mL (U-100) available as:

- 10 mL multiple-dose vial (3)
- 3 mL single-patient-use prefilled pen (3)

CONTRAINDICATIONS

- During episodes of hypoglycemia (4)
- Hypersensitivity to insulin glargine products or any excipient in SEMGLEE (4)

WARNINGS AND PRECAUTIONS

- *Never share* a SEMGLEE prefilled pen, insulin syringe, or needle between patients, even if the needle is changed. (5.1)
- *Hyperglycemia or hypoglycemia with changes in insulin regimen*: Make changes to a patient's insulin regimen (e.g., insulin strength, manufacturer, type, injection site or method of administration) under close medical supervision with increased frequency of blood glucose monitoring. (5.2)
- *Hypoglycemia*: May be life-threatening. Increase frequency of glucose monitoring with changes to: insulin dosage, concomitant drugs, meal pattern, physical activity; and in patients with renal or hepatic impairment and hypoglycemia unawareness. (5.3, 6.1)
- *Hypoglycemia due to Medication Errors*: Accidental mix-ups between insulin products can occur. Instruct patients to check insulin labels before injection. (5.4, 6.3)
- *Hypersensitivity reactions*: Severe, life-threatening, generalized allergy, including anaphylaxis, can occur. Discontinue SEMGLEE. Monitor and treat if indicated. (5.5, 6.1)
- *Hypokalemia*: May be life-threatening. Monitor potassium levels in patients at risk of hypokalemia and treat if indicated. (5.6)
- *Fluid retention and heart failure with concomitant use of thiazolidinediones (TZDs)*: Observe for signs and symptoms of heart failure; consider dosage reduction or discontinuation of TZD if heart failure occurs. (5.7)

ADVERSE REACTIONS

Adverse reactions commonly associated with insulin glargine products include hypoglycemia, allergic reactions, injection site reactions, lipodystrophy, pruritus, rash, edema and weight gain. (6.1)

To report **SUSPECTED ADVERSE REACTIONS**, contact **Biocon Biologics at 1-833-986-1468** or **FDA at 1-800-FDA-1088** or **www.fda.gov/medwatch**

-----**DRUG INTERACTIONS**-----

- *Drugs that Affect Glucose Metabolism*: Adjustment of insulin dosage may be needed. (7)
- *Antiadrenergic Drugs* (e.g., beta-blockers, clonidine, guanethidine, and reserpine): Signs and symptoms of hypoglycemia may be reduced or absent. (5.3, 7)

* An interchangeable product (IP) is a biological product that is approved based on data demonstrating that it is highly similar to an FDA-approved reference product (RP) and that there are no clinically meaningful differences between the products; it can be expected to produce the same clinical result as the RP in any given patient; and if administered more than once to a patient, the risk in terms of safety or diminished efficacy from alternating or switching between use of the RP and IP is not greater than that from the RP without such alternation or switch. Interchangeability of SEMGLEE has been demonstrated for the condition(s) of use, strength(s), dosage form(s), and route(s) of administration described in its Full Prescribing Information.

See 17 for PATIENT COUNSELING INFORMATION and FDA-approved patient labeling.

Revised: 7/2023

FULL PRESCRIBING INFORMATION: CONTENTS*

1 INDICATIONS AND USAGE

2 DOSAGE AND ADMINISTRATION

- 2.1 Important Administration Instructions
- 2.2 General Dosing Instructions
- 2.3 Initiation of SEMGLEE Therapy
- 2.4 Switching to SEMGLEE from Other Insulin Therapies

3 DOSAGE FORMS AND STRENGTHS

4 CONTRAINDICATIONS

5 WARNINGS AND PRECAUTIONS

- 5.1 Never Share a SEMGLEE Prefilled Pen, Insulin Syringe, or Needle Between Patients
- 5.2 Hyperglycemia or Hypoglycemia with Changes in Insulin Regimen
- 5.3 Hypoglycemia
- 5.4 Hypoglycemia Due to Medication Errors
- 5.5 Hypersensitivity Reactions
- 5.6 Hypokalemia
- 5.7 Fluid Retention and Heart Failure with Concomitant Use of PPAR-gamma Agonists

6 ADVERSE REACTIONS

- 6.1 Clinical Trials Experience
- 6.2 Immunogenicity
- 6.3 Postmarketing Experience

7 DRUG INTERACTIONS

8 USE IN SPECIFIC POPULATIONS

- 8.1 Pregnancy
- 8.2 Lactation
- 8.4 Pediatric Use
- 8.5 Geriatric Use
- 8.6 Renal Impairment
- 8.7 Hepatic Impairment

10 OVERDOSAGE

11 DESCRIPTION

12 CLINICAL PHARMACOLOGY

12.1 Mechanism of Action

12.2 Pharmacodynamics

12.3 Pharmacokinetics

13 NONCLINICAL TOXICOLOGY

13.1 Carcinogenesis, Mutagenesis, Impairment of Fertility

14 CLINICAL STUDIES

14.1 Overview of Clinical Studies

14.2 Clinical Studies in Adult and Pediatric Patients with Type 1 Diabetes

14.3 Clinical Studies in Adults with Type 2 Diabetes

14.4 Additional Clinical Studies in Adults with Diabetes Type 1 and Type 2

16 HOW SUPPLIED/STORAGE AND HANDLING

16.1 How Supplied

16.2 Storage

17 PATIENT COUNSELING INFORMATION

* Sections or subsections omitted from the full prescribing information are not listed.

FULL PRESCRIBING INFORMATION

1 INDICATIONS AND USAGE

SEMGLEE is indicated to improve glycemic control in adult and pediatric patients with diabetes mellitus.

Limitations of Use

SEMGLEE is not recommended for the treatment of diabetic ketoacidosis.

2 DOSAGE AND ADMINISTRATION

2.1 Important Administration Instructions

- Always check insulin labels before administration [see *Warnings and Precautions* (5.4)]
- Visually inspect SEMGLEE vials and prefilled pens for particulate matter and discoloration prior to administration. Only use if the solution is clear and colorless with no visible particles.
- Administer SEMGLEE subcutaneously into the abdominal area, thigh, or deltoid, and rotate injection sites within the same region from one injection to the next to reduce the risk of lipodystrophy and localized cutaneous amyloidosis. Do not inject into areas of lipodystrophy or localized cutaneous amyloidosis [see *Warnings and Precautions* (5.2), and *Adverse Reactions* (6)].
- During changes to a patient's insulin regimen, increase the frequency of blood glucose monitoring [see *Warnings and Precautions* (5.2)].
- Do not administer intravenously or via an insulin pump.
- Do not dilute or mix SEMGLEE with any other insulin or solution.

- The SEMGLEE prefilled pen dials in 1-unit increments.
- Use SEMGLEE prefilled pen with caution in patients with visual impairment who may rely on audible clicks to dial their dose.

2.2 General Dosing Instructions

- Administer SEMGLEE subcutaneously once daily at any time of day but at the same time every day.
- Individualize and adjust the dosage of SEMGLEE based on the patient's metabolic needs, blood glucose monitoring results and glycemic control goal.
- Dosage adjustments may be needed with changes in physical activity, changes in meal patterns (i.e., macronutrient content or timing of food intake), during acute illness, or changes in renal or hepatic function. Dosage adjustments should only be made under medical supervision with appropriate glucose monitoring [see *Warnings and Precautions* (5.2)].
- In patients with type 1 diabetes, SEMGLEE must be used concomitantly with short-acting insulin.

2.3 Initiation of SEMGLEE Therapy

- Recommended Starting Dosage in Patients with Type 1 Diabetes
The recommended starting dosage of SEMGLEE in patients with type 1 diabetes is approximately one-third of the total daily insulin requirements. Use short-acting, premeal insulin to satisfy the remainder of the daily insulin requirements.
- Recommended Starting Dosage in Patients with Type 2 Diabetes
The recommended starting dosage of SEMGLEE in patients with type 2 diabetes who are not currently treated with insulin is 0.2 units/kg or up to 10 units once daily.

2.4 Switching to SEMGLEE from Other Insulin Therapies

Dosage adjustments are recommended to lower the risk of hypoglycemia when switching patients to SEMGLEE from other insulin therapies [see *Warnings and Precautions* (5.3)]. When switching from:

- Once-daily insulin glargine 300 units/mL to once-daily SEMGLEE (100 units/mL), the recommended starting SEMGLEE dosage is 80% of the insulin glargine, 300 units/mL dosage that is being discontinued.
- Once-daily NPH insulin to once-daily SEMGLEE, the recommended starting SEMGLEE dosage is the same as the dosage of NPH that is being discontinued.
- Twice-daily NPH insulin to once-daily SEMGLEE, the recommended starting SEMGLEE dosage is 80% of the total NPH dosage that is being discontinued.

3 DOSAGE FORMS AND STRENGTHS

Injection: 100 units/mL (U-100) clear and colorless solution available as:

- 10 mL multiple-dose vial
- 3 mL single-patient-use prefilled pen

4 CONTRAINDICATIONS

SEMGLEE is contraindicated:

- During episodes of hypoglycemia [see *Warnings and Precautions* (5.3)].
- In patients with hypersensitivity to insulin glargine products or any of the excipients

in SEMGLEE [see *Warnings and Precautions (5.5)*].

5 WARNINGS AND PRECAUTIONS

5.1 Never Share a SEMGLEE Prefilled Pen, Insulin Syringe, or Needle Between Patients

SEMGLEE prefilled pens must never be shared between patients, even if the needle is changed. Patients using SEMGLEE vials must never re-use or share needles or syringes with another person. Sharing poses a risk for transmission of blood-borne pathogens.

5.2 Hyperglycemia or Hypoglycemia with Changes in Insulin Regimen

Changes in an insulin regimen (e.g., insulin strength, manufacturer, type, injection site or method of administration) may affect glycemic control and predispose to hypoglycemia [see *Warnings and Precautions (5.3)*] or hyperglycemia. Repeated insulin injections into areas of lipodystrophy or localized cutaneous amyloidosis have been reported to result in hyperglycemia; and a sudden change in the injection site (to unaffected area) has been reported to result in hypoglycemia [see *Adverse Reactions (6)*].

Make any changes to a patient's insulin regimen under close medical supervision with increased frequency of blood glucose monitoring. Advise patients who have repeatedly injected into areas of lipodystrophy or localized cutaneous amyloidosis to change the injection site to unaffected areas and closely monitor for hypoglycemia. For patients with type 2 diabetes, dosage adjustments of concomitant oral and antidiabetic products may be needed.

5.3 Hypoglycemia

Hypoglycemia is the most common adverse reaction associated with insulins, including insulin glargine products. Severe hypoglycemia can cause seizures, may be life-threatening or cause death. Hypoglycemia can impair concentration ability and reaction time; this may place the patients and others at risk in situations where these abilities are important (e.g., driving or operating other machinery).

Hypoglycemia can happen suddenly, and symptoms may differ in each patient and change over time in the same patient. Symptomatic awareness of hypoglycemia may be less pronounced in patients with longstanding diabetes, in patients with diabetic neuropathy, using drugs that block the sympathetic nervous system (e.g., beta-blockers) [see *Drug Interactions (7)*], or who experience recurrent hypoglycemia.

The long-acting effect of insulin glargine products may delay recovery from hypoglycemia.

Risk Factors for Hypoglycemia

The risk of hypoglycemia after an injection is related to the duration of action of the insulin and, in general, is highest when the glucose lowering effect of the insulin is maximal. As with all insulins, the glucose lowering effect time course of insulin glargine products may vary in different patients or at different times in the same patient and depends on many conditions, including the area of injection as well as the injection site blood supply and temperature [see *Clinical Pharmacology (12.2)*]. Other factors which may increase the risk of hypoglycemia include changes in meal pattern (e.g., macronutrient content or timing of meals), changes in level of physical activity, or

changes to concomitant drugs [*see Drug Interactions (7)*]. Patients with renal or hepatic impairment may be at higher risk of hypoglycemia [*see Use in Specific Populations (8.6, 8.7)*].

Risk Mitigation Strategies for Hypoglycemia

Patients and caregivers must be educated to recognize and manage hypoglycemia. Self-monitoring of blood glucose plays an essential role in the prevention and management of hypoglycemia. In patients at higher risk for hypoglycemia and patients who have reduced symptomatic awareness of hypoglycemia, increased frequency of blood glucose monitoring is recommended.

5.4 Hypoglycemia Due to Medication Errors

Accidental mix-ups among insulin products have been reported. To avoid medication errors between SEMGLEE and other insulins, instruct patients to always check the insulin label before each injection [*see Adverse Reactions (6.3)*].

5.5 Hypersensitivity Reactions

Severe, life-threatening, generalized allergy, including anaphylaxis, can occur with insulins, including insulin glargine products [*see Adverse Reactions (6.1)*]. If hypersensitivity reactions occur, discontinue SEMGLEE; treat per standard of care and monitor until symptoms and signs resolve. SEMGLEE is contraindicated in patients who have had hypersensitivity reactions to insulin glargine products or one of the excipients.

5.6 Hypokalemia

All insulins, including insulin glargine products, cause a shift in potassium from the extracellular to intracellular space, possibly leading to hypokalemia. Untreated hypokalemia may cause respiratory paralysis, ventricular arrhythmia, and death. Monitor potassium levels in patients at risk for hypokalemia, if indicated (e.g., patients using potassium-lowering medications, patients taking medications sensitive to serum potassium concentrations).

5.7 Fluid Retention and Heart Failure with Concomitant Use of PPAR-gamma Agonists

Thiazolidinediones (TZDs), which are peroxisome proliferator-activated receptor (PPAR)-gamma agonists, can cause dose-related fluid retention, when used in combination with insulin. Fluid retention may lead to or exacerbate heart failure. Patients treated with insulin including SEMGLEE, and a PPAR-gamma agonist should be observed for signs and symptoms of heart failure. If heart failure develops, it should be managed according to current standards of care, and discontinuation or dose reduction of the PPAR-gamma agonist must be considered.

6 ADVERSE REACTIONS

The following adverse reactions are discussed elsewhere:

- Hypoglycemia [*see Warnings and Precautions (5.3)*]
- Hypoglycemia Due to Medication Errors [*see Warnings and Precautions (5.4)*]
- Hypersensitivity Reactions [*see Warnings and Precautions (5.5)*]
- Hypokalemia [*see Warnings and Precautions (5.6)*]

6.1 Clinical Trials Experience

Because clinical trials are conducted under widely varying conditions, adverse reaction rates observed in clinical trials of a drug cannot be directly compared to rates in the clinical trial of another drug and may not reflect the rates observed in practice.

The data in Table 1 reflect the exposure of 2,327 patients with type 1 diabetes to insulin glargine or NPH in Studies A, B, C, and D [see *Clinical Studies (14.2)*]. The type 1 diabetes population had the following characteristics: Mean age was 39 years. Fifty four percent were male, 97% were Caucasian, 2% were Black or African American and 3% were Hispanic. The mean BMI was 25.1 kg/m².

The data in Table 2 reflect the exposure of 1,563 patients with type 2 diabetes to insulin glargine or NPH in Studies E, F, and G [see *Clinical Studies (14.3)*]. The type 2 diabetes population had the following characteristics: Mean age was 59 years. Fifty eight percent were male, 87% were Caucasian, 8% were Black or African American and 9% were Hispanic. The mean BMI was 29.2 kg/m².

The frequencies of adverse reactions during insulin glargine clinical studies in patients with type 1 diabetes mellitus and type 2 diabetes mellitus are listed in the tables below (Tables 1, 2, 3, and 4).

Table 1: Adverse Reactions Occurring >5% in Pooled Clinical Studies up to 28 Weeks Duration in Adults with Type 1 Diabetes

	Insulin Glargine, % (n = 1257)	NPH,% (n = 1070)
Upper respiratory tract infection	22.4	23.1
Infection*	9.4	10.3
Accidental injury	5.7	6.4
Headache	5.5	4.7

* Body system not specified

Table 2: Adverse Reactions Occurring >5% in Pooled Clinical Studies up to 1 Year Duration in Adults with Type 2 Diabetes

	Insulin Glargine, % (n = 849)	NPH,% (n = 714)
Upper respiratory tract infection	11.4	13.3
Infection*	10.4	11.6
Retinal vascular disorder	5.8	7.4

* Body system not specified

Table 3: Adverse Reactions Occurring >10% in a 5 Year Study of Adults with

Type 2 Diabetes

	Insulin Glargine, % (n = 514)	NPH,% (n = 503)
Upper respiratory tract infection	29.0	33.6
Edema peripheral	20.0	22.7
Hypertension	19.6	18.9
Influenza	18.7	19.5
Sinusitis	18.5	17.9
Cataract	18.1	15.9
Bronchitis	15.2	14.1
Arthralgia	14.2	16.1
Pain in extremity	13.0	13.1
Back pain	12.8	12.3
Cough	12.1	7.4
Urinary tract infection	10.7	10.1
Diarrhea	10.7	10.3
Depression	10.5	9.7
Headache	10.3	9.3

Table 4: Adverse Reactions Occurring >5% in a 28-Week Clinical Study in Pediatric Patients with Type 1 Diabetes

	Insulin Glargine, % (n = 174)	NPH,% (n = 175)
Infection*	13.8	17.7
Upper respiratory tract infection	13.8	16.0
Pharyngitis	7.5	8.6
Rhinitis	5.2	5.1

* Body system not specified

Severe Hypoglycemia

Hypoglycemia was the most commonly observed adverse reaction in patients treated with insulin glargine. Tables 5, 6, and 7 summarize the incidence of severe hypoglycemia in the insulin glargine clinical Studies. Severe symptomatic hypoglycemia was defined as an event with symptoms consistent with hypoglycemia requiring the assistance of another person and associated with either a blood glucose below 50 mg/dL (≤ 56 mg/dL in the 5-year study and ≤ 36 mg/dL in the ORIGIN study) or prompt recovery after oral carbohydrate, intravenous glucose or glucagon administration.

Percentages of insulin glargine-treated adult patients who experienced severe symptomatic hypoglycemia in the insulin glargine clinical studies [see *Clinical Studies (14)*] were comparable to percentages of NPH-treated patients for all treatment regimens (see Tables 5 and 6). In the pediatric clinical study, pediatric patients with type 1 diabetes had a higher incidence of severe symptomatic hypoglycemia in the two treatment groups

compared to the adult studies with type 1 diabetes.

Table 5: Severe Symptomatic Hypoglycemia in Patients with Type 1 Diabetes

	Study A Type 1 Diabetes Adults 28 weeks In combination with regular insulin		Study B Type 1 Diabetes Adults 28 weeks In combination with regular insulin		Study C Type 1 Diabetes Adults 16 weeks In combination with insulin lispro		Study D Type 1 Diabetes Pediatrics 26 weeks In combination with regular insulin	
	Insulin Glargine N = 292	NPH N = 293	Insulin Glargine N = 264	NPH N = 270	Insulin Glargine N = 310	NPH N = 309	Insulin Glargine N = 174	NPH N = 175
Percent of patients	10.6	15.0	8.7	10.4	6.5	5.2	23.0	28.6

Table 6: Severe Symptomatic Hypoglycemia in Patients with Type 2 Diabetes

	Study E Type 2 Diabetes Adults 52 weeks In combination with oral agents		Study F Type 2 Diabetes Adults 28 weeks In combination with regular insulin		Study G Type 2 Diabetes Adults 5 years In combination with regular insulin	
	Insulin Glargine N = 289	NPH N = 281	Insulin Glargine N = 259	NPH N = 259	Insulin Glargine N = 513	NPH N = 504
Percent of patients	1.7	1.1	0.4	2.3	7.8	11.9

Table 7 displays the proportion of patients who experienced severe symptomatic hypoglycemia in the insulin glargine and Standard Care groups in the ORIGIN study [see *Clinical Studies (14)*].

Table 7: Severe Symptomatic Hypoglycemia in the ORIGIN Study

	ORIGIN Study Medium duration of follow-up: 6.2 years	
	Insulin Glargine N = 6231	Standard Care N = 6273
Percent of patients	5.6	1.8

Peripheral Edema

Some patients taking insulin glargine products have experienced sodium retention and edema, particularly if previously poor metabolic control was improved by intensified

insulin therapy.

Lipodystrophy

Administration of insulin subcutaneously, including insulin glargine products, has resulted in lipoatrophy (depression in the skin) or lipohypertrophy (enlargement or thickening of tissue) in some patients [see *Dosage and Administration (2.2)*].

Insulin Initiation and Intensification of Glucose Control

Intensification or rapid improvement in glucose control has been associated with a transitory, reversible ophthalmologic refraction disorder, worsening of diabetic retinopathy, and acute painful peripheral neuropathy. However, long-term glycemic control decreases the risk of diabetic retinopathy and neuropathy.

Weight Gain

Weight gain has occurred with insulin including insulin glargine products and has been attributed to the anabolic effects of insulin and the decrease in glucosuria.

Hypersensitivity Reactions

Local Reactions

Patients taking insulin glargine experienced injection site reactions, including redness, pain, itching, urticaria, edema, and inflammation. In clinical studies in adult patients, there was a higher incidence of treatment-emergent injection site pain in insulin glargine-treated patients (2.7%) compared to NPH insulin-treated patients (0.7%). The reports of pain at the injection site did not result in discontinuation of therapy.

Systemic Reactions

Severe, life-threatening, generalized allergy, including anaphylaxis, generalized skin reactions, angioedema, bronchospasm, hypotension, and shock have occurred with insulin, including insulin glargine products and may be life threatening.

6.2 Immunogenicity

As with all therapeutic proteins, there is potential for immunogenicity. The detection of antibody formation is highly dependent on the sensitivity and specificity of the assay. Additionally, the observed incidence of antibody (including neutralizing antibody) positivity in an assay may be influenced by several factors, including assay methodology, sample handling, timing of sample collection, concomitant medications, and underlying disease. For these reasons, comparison of the incidence of antibodies in the studies described below with the incidence of antibodies in other studies or to other insulin glargine products may be misleading.

All insulin products can elicit the formation of insulin antibodies. The presence of such insulin antibodies may increase or decrease the efficacy of insulin and may require adjustment of the insulin dose. In clinical studies of insulin glargine, increases in titers of antibodies to insulin were observed in NPH insulin and insulin glargine treatment groups with similar incidences.

6.3 Postmarketing Experience

The following adverse reactions have been identified during postapproval use of insulin glargine products. Because these reactions are reported voluntarily from a population of uncertain size, it is not always possible to reliably estimate their frequency or establish a causal relationship to drug exposure.

Medication errors have been reported in which rapid-acting insulins and other insulins have been accidentally administered instead of insulin glargine products.

Localized cutaneous amyloidosis at the injection site has occurred. Hyperglycemia has been reported with repeated insulin injections into areas of localized cutaneous amyloidosis; hypoglycemia has been reported with a sudden change to an unaffected injection site.

7 DRUG INTERACTIONS

Table 8 includes clinically significant drug interactions with SEMGLEE.

Table 8: Clinically Significant Drug Interactions with SEMGLEE

Drugs that May Increase the Risk of Hypoglycemia	
<i>Drugs:</i>	Antidiabetic agents, ACE inhibitors, angiotensin II receptor blocking agents, disopyramide, fibrates, fluoxetine, monoamine oxidase inhibitors, pentoxifylline, pramlintide, salicylates, somatostatin analogs (e.g., octreotide), sulfonamide antibiotics, GLP-1 receptor agonists, DPP-4 inhibitors, and SGLT-2 inhibitors.
<i>Intervention:</i>	Dosage reductions and increased frequency of glucose monitoring may be required when SEMGLEE is coadministered with these drugs.
Drugs that May Decrease the Blood Glucose Lowering Effect of SEMGLEE	
<i>Drugs:</i>	Atypical antipsychotics (e.g., olanzapine and clozapine), corticosteroids, danazol, diuretics, estrogens, glucagon, isoniazid, niacin, oral contraceptives, phenothiazines, progestogens (e.g., in oral contraceptives), protease inhibitors, somatropin, sympathomimetic agents (e.g., albuterol, epinephrine, terbutaline), and thyroid hormones.
<i>Intervention:</i>	Dosage increases and increased frequency of glucose monitoring may be required when SEMGLEE is coadministered with these drugs.
Drugs that May Increase or Decrease the Blood Glucose Lowering Effect of SEMGLEE	
<i>Drugs:</i>	Alcohol, beta-blockers, clonidine, and lithium salts. Pentamidine may cause hypoglycemia, which may sometimes be followed by hyperglycemia.
<i>Intervention:</i>	Dosage adjustment and increased frequency of glucose monitoring may be required when SEMGLEE is coadministered with these drugs.
Drugs that May Blunt Signs and Symptoms of Hypoglycemia	
<i>Drugs:</i>	Beta-blockers, clonidine, guanethidine, and reserpine
<i>Intervention:</i>	Increased frequency of glucose monitoring may be required when SEMGLEE is coadministered with these drugs.

8 USE IN SPECIFIC POPULATIONS

8.1 Pregnancy

Risk Summary

Published studies with use of insulin glargine products during pregnancy have not reported a clear association with insulin glargine products and adverse developmental outcomes (*see Data*). There are risks to the mother and fetus associated with poorly controlled diabetes in pregnancy (*see Clinical Considerations*).

Rats and rabbits were exposed to insulin glargine in animal reproduction studies during organogenesis, respectively 50 times and 10 times the human subcutaneous dosage of 0.2 units/kg/day. Overall, the effects of insulin glargine did not generally differ from those observed with regular human insulin (*see Data*).

In the U.S. general population, the estimated background risk of major birth defects and miscarriage in clinically recognized pregnancies is 2% to 4% and 15% to 20%, respectively. The estimated background risk of major birth defects is 6% to 10% in women with pregestational diabetes with a peri-conceptual HbA_{1c} >7 and has been reported to be as high as 20% to 25% in women with a peri-conceptual HbA_{1c} >10. The estimated background risk of miscarriage for the indicated population is unknown.

Clinical Considerations

Disease-Associated Maternal and/or Embryo-fetal Risk

Hypoglycemia and hyperglycemia occur more frequently during pregnancy in patients with pre-gestational diabetes. Poorly controlled diabetes in pregnancy increases the maternal risk for diabetic ketoacidosis, preeclampsia, spontaneous abortions, preterm delivery, and delivery complications. Poorly controlled diabetes increases the fetal risk for major birth defects, stillbirth, and macrosomia-related morbidity.

Data

Human Data

Published data do not report a clear association with insulin glargine products and major birth defects, miscarriage, or adverse maternal or fetal outcomes when insulin glargine is used during pregnancy. However, these studies cannot definitely establish the absence of any risk because of methodological limitations including small sample size and some lacking comparator groups.

Animal Data

Subcutaneous reproduction and teratology studies have been performed with insulin glargine and regular human insulin in rats and Himalayan rabbits. Insulin glargine was given to female rats before mating, during mating, and throughout pregnancy at doses up to 0.36 mg/kg/day, which is approximately 50 times the recommended human subcutaneous starting dosage of 0.2 units/kg/day (0.007 mg/kg/day), on a mg/kg basis. In rabbits, doses of 0.072 mg/kg/day, which is approximately 10 times the recommended human subcutaneous starting dosage of 0.2 units/kg/day on a mg/kg basis, were administered during organogenesis. The effects of insulin glargine did not generally differ from those observed with regular human insulin in rats or rabbits. However, in rabbits, five fetuses from two litters of the high-dose group exhibited dilation of the cerebral ventricles. Fertility and early embryonic development appeared

normal.

8.2 Lactation

Risk Summary

There are either no or only limited data on the presence of insulin glargine products in human milk, the effects on breastfed infant, or the effects on milk production. Endogenous insulin is present in human milk. The developmental and health benefits of breastfeeding should be considered along with the mother's clinical need for SEMGLEE, and any potential adverse effects on the breastfed child from SEMGLEE or from the underlying maternal condition.

8.4 Pediatric Use

The safety and effectiveness of insulin glargine products to improve glycemic control in pediatric patients with diabetes mellitus have been established. Use of insulin glargine for this indication is supported by evidence from an adequate and well-controlled study (Study D) in 174 insulin glargine-treated pediatric patients aged 6 to 15 years with type 1 diabetes mellitus and from adequate and well-controlled studies of insulin glargine in adults with diabetes mellitus [see *Clinical Pharmacology (12.3)*, *Clinical Studies (14.2)*].

In the pediatric clinical study, pediatric patients with type 1 diabetes had a higher incidence of severe symptomatic hypoglycemia compared to the adults in studies with type 1 diabetes [see *Adverse Reactions (6.1)*].

8.5 Geriatric Use

Of the total number of subjects in controlled clinical studies of patients with type 1 and type 2 diabetes who were treated with insulin glargine, 15% (n=316) were \geq 65 years of age and 2% (n=42) were \geq 75 years of age. No overall differences in safety or effectiveness of insulin glargine have been observed between patients 65 years of age and older and younger adult patients.

Nevertheless, caution should be exercised when SEMGLEE is administered to geriatric patients. In geriatric patients with diabetes, the initial dosing, dosage increments, and maintenance dosage should be conservative to avoid hypoglycemic reactions. Hypoglycemia may be difficult to recognize in geriatric patients.

8.6 Renal Impairment

The effect of kidney impairment on the pharmacokinetics of insulin glargine products has not been studied. Some studies with human insulin have shown increased circulating levels of insulin in patients with kidney failure. Frequent glucose monitoring and dosage adjustment may be necessary for SEMGLEE in patients with kidney impairment [see *Warnings and Precautions (5.3)*].

8.7 Hepatic Impairment

The effect of hepatic impairment on the pharmacokinetics of insulin glargine products has not been studied. Frequent glucose monitoring and dosage adjustment may be necessary for SEMGLEE in patients with hepatic impairment [see *Warnings and Precautions (5.3)*].

10 OVERDOSAGE

Excess insulin administration may cause hypoglycemia and hypokalemia [see *Warnings and Precautions* (5.3, 5.6)].

Mild episodes of hypoglycemia can usually be treated with oral carbohydrates. Lowering the insulin dosage, and adjustments in meal patterns, or exercise may be needed.

More severe episodes of hypoglycemia with coma, seizure, or neurologic impairment may be treated with glucagon for emergency use or concentrated intravenous glucose. After apparent clinical recovery from hypoglycemia, continued observation and additional carbohydrate intake may be necessary to avoid recurrence of hypoglycemia.

Hypokalemia must be corrected appropriately.

11 DESCRIPTION

Insulin glargine-yfgn is a long-acting human insulin analog produced by recombinant DNA technology utilizing a recombinant yeast strain, *Pichia pastoris*. Insulin glargine-yfgn differs from human insulin in that the amino acid asparagine at position A21 is replaced by glycine and two arginines are added to the C-terminus of the B-chain. Insulin glargine-yfgn has a molecular weight of 6063 Da.

SEMGLEE (insulin glargine-yfgn) injection is a sterile, clear and colorless solution for subcutaneous use in a 10 mL multiple-dose vial and a 3 mL single-patient-use prefilled pen.

Vial

Each mL contains 100 units of insulin glargine-yfgn and the inactive ingredients: glycerol (20 mg), metacresol (2.7 mg), polysorbate-20 (20 mcg), zinc chloride (content adjusted to provide 30 mcg zinc ion), and Water for Injection, USP.

Prefilled pen

Each mL contains 100 units of insulin glargine-yfgn and the inactive ingredients: glycerol (20 mg), metacresol (2.7 mg), zinc chloride (content adjusted to provide 30 mcg zinc ion), and Water for Injection, USP.

The pH is adjusted by addition of aqueous solutions of hydrochloric acid and/or sodium hydroxide. SEMGLEE has a pH of approximately 4.

12 CLINICAL PHARMACOLOGY

12.1 Mechanism of Action

The primary activity of insulin, including insulin glargine products, is regulation of glucose metabolism. Insulin and its analogs lower blood glucose by stimulating peripheral glucose uptake, especially by skeletal muscle and fat, and by inhibiting hepatic glucose production. Insulin inhibits lipolysis and proteolysis and enhances protein synthesis.

12.2 Pharmacodynamics

In clinical studies, the glucose-lowering effect on a molar basis (i.e., when given at the same doses) of intravenous insulin glargine is approximately the same as that for

human insulin. Figure 1 shows results from a study in patients with type 1 diabetes conducted for a maximum of 24 hours after subcutaneous injection of insulin glargine or NPH insulin. The median time between subcutaneous injection and the end of pharmacological effect was 14.5 hours (range: 9.5 to 19.3 hours) for NPH insulin, and 24 hours (range: 10.8 to > 24.0 hours) (24 hours was the end of the observation period) for insulin glargine.

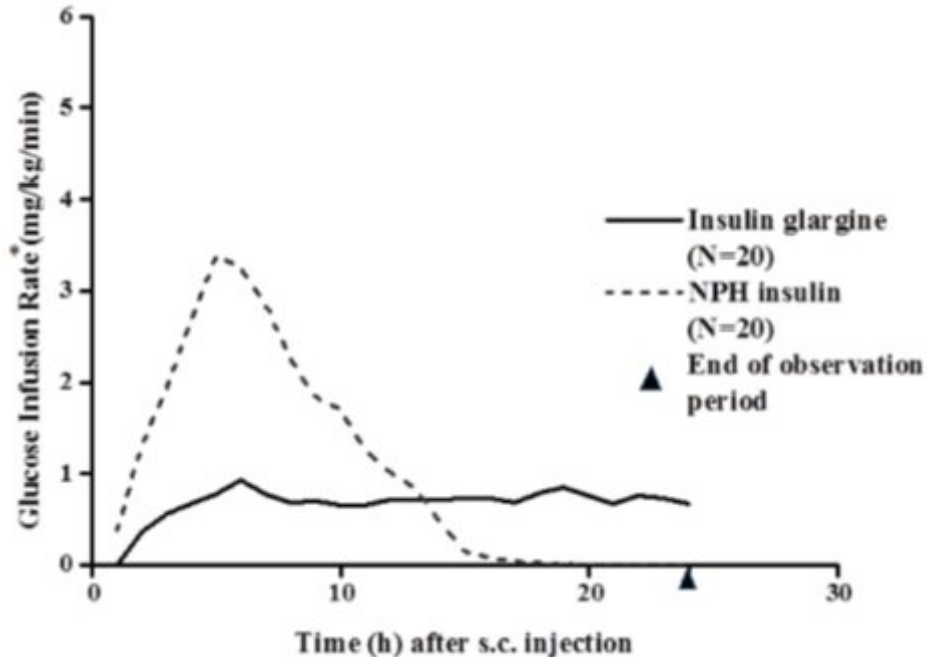

Figure 1: Glucose-Lowering Effect Over 24 Hours in Patients with Type 1 Diabetes

* Determined as amount of glucose infused to maintain constant plasma glucose levels
The duration of action after abdominal, deltoid, or thigh subcutaneous administration of insulin glargine was similar. The time course of action of insulins, including insulin glargine products, may vary between patients and within the same patient.

12.3 Pharmacokinetics

Absorption

After subcutaneous injection of insulin glargine in healthy subjects and in patients with diabetes, the insulin serum concentrations indicated a slower, more prolonged absorption and a relatively constant concentration/time profile over 24 hours with no pronounced peak in comparison to NPH insulin.

Elimination

Metabolism

A metabolism study in humans indicates that insulin glargine is partly metabolized at the carboxyl terminus of the B chain in the subcutaneous depot to form two active metabolites with in vitro activity similar to that of human insulin, M1 (21^A-Gly-insulin) and M2 (21^A-Gly-des-30^B-Thr-insulin). Unchanged drug and these degradation products are also present in the circulation.

Specific Populations

Age, Race, Body Mass Index and Gender

Effect of age, race, body mass index (BMI) and gender on the pharmacokinetics of insulin glargine products has not been evaluated. However, in controlled clinical studies in adults (n = 3,890) and a controlled clinical study in pediatric patients (n = 349), subgroup analyses based on age, race, BMI and gender did not show differences in safety and efficacy between insulin glargine and NPH insulin [see *Clinical Studies (14)*].

13 NONCLINICAL TOXICOLOGY

13.1 Carcinogenesis, Mutagenesis, Impairment of Fertility

In mice and rats, standard two-year carcinogenicity studies with insulin glargine were performed at doses up to 0.455 mg/kg, which was for the rat approximately 65 times the recommended human subcutaneous starting dosage of 0.2 units/kg/day (0.007 mg/kg/day) on a mg/kg basis. Histiocytomas were found at injection sites in male rats and mice in acid vehicle containing groups and are considered a response to chronic tissue irritation and inflammation in rodents. These tumors were not found in female animals, in saline control, or insulin comparator groups using a different vehicle.

Insulin glargine was not mutagenic in tests for detection of gene mutations in bacteria and mammalian cells (Ames and HGPRT-test) and in tests for detection of chromosomal aberrations (cytogenetics in vitro in V79 cells and in vivo in Chinese hamsters).

In a combined fertility and prenatal and postnatal study in male and female rats at subcutaneous doses up to 0.36 mg/kg/day, which was approximately 50 times the recommended human subcutaneous starting dose of 0.2 units/kg/day (0.007 mg/kg/day) maternal toxicity due to dose-dependent hypoglycemia, including some deaths, was observed. Consequently, a reduction of the rearing rate occurred in the high-dose group only. Similar effects were observed with NPH insulin.

14 CLINICAL STUDIES

14.1 Overview of Clinical Studies

The safety and effectiveness of insulin glargine given once-daily at bedtime was compared to that of once-daily and twice-daily NPH insulin in open-label, randomized, active-controlled, parallel studies of 2,327 adult patients and 349 pediatric patients with type 1 diabetes mellitus and 1,563 adult patients with type 2 diabetes mellitus (see Tables 9-11). In general, the reduction in glycated hemoglobin (HbA1c) with insulin glargine was similar to that with NPH insulin.

14.2 Clinical Studies in Adult and Pediatric Patients with Type 1 Diabetes

Adult Patients with Type 1 Diabetes

In two clinical studies (Studies A and B), adult patients with type 1 diabetes (Study A; n = 585, Study B n = 534) were randomized to 28 weeks of basal-bolus treatment with insulin glargine or NPH insulin. Regular human insulin was administered before each meal. Insulin glargine was administered at bedtime. NPH insulin was administered either as once daily at bedtime or in the morning and at bedtime when used twice daily.

In Study A, the average age was 39 years. The majority of patients were White (99%) and 56% were male. The mean BMI was approximately 24.9 kg/m². The mean duration of diabetes was 16 years.

In Study B, the average age was 39 years. The majority of patients were White (95%) and 51% were male. The mean BMI was approximately 25.8 kg/m². The mean duration of diabetes was 17 years.

In another clinical study (Study C), patients with type 1 diabetes (n = 619) were randomized to 16 weeks of basal-bolus treatment with insulin glargine or NPH insulin. Insulin lispro was used before each meal. Insulin glargine was administered once daily at bedtime and NPH insulin was administered once or twice daily. The average age was 39 years. The majority of patients were White (97%) and 51% were male. The mean BMI was approximately 25.6 kg/m². The mean duration of diabetes was 19 years.

In these 3 adult studies, insulin glargine and NPH insulin had similar effects on HbA1c (Table 9) with a similar overall rate of severe symptomatic hypoglycemia [see Adverse Reactions (6.1)].

Table 9: Type 1 Diabetes Mellitus - Adults

Treatment duration Treatment in combination with	Study A 28 weeks Regular insulin		Study B 28 weeks Regular insulin		Study C 16 weeks Insulin lispro	
	Insulin Glargine	NPH	Insulin Glargine	NPH	Insulin Glargine	NPH
Number of subjects treated	292	293	264	270	310	309
HbA1c						
Baseline HbA1c	8.0	8.0	7.7	7.7	7.6	7.7
Adjusted mean change at study end	+0.2	+0.1	-0.2	-0.2	-0.1	-0.1
Treatment Difference (95% CI)	+0.1 (0.0; +0.2)		+0.1 (-0.1; +0.2)		0.0 (-0.1; +0.1)	
Basal insulin dose						
Baseline mean	21	23	29	29	28	28
Mean change from baseline	-2	0	-4	+2	-5	+1
Total insulin dose						
Baseline mean	48	52	50	51	50	50
Mean change from baseline	-1	0	0	+4	-3	0
Fasting blood glucose (mg/dL)						
Baseline mean	167	166	166	175	175	173
Adj. mean change from baseline	-21	-16	-20	-17	-29	-12
Body weight (kg)						
Baseline mean	73.2	74.8	75.5	75.0	74.8	75.6
Mean change from baseline	0.1	-0.0	0.7	1.0	0.1	0.5

Pediatric Patients with Type 1 Diabetes

In a randomized, controlled clinical study (Study D), pediatric patients (age range 6 to 15 years) with type 1 diabetes (n = 349) were treated for 28 weeks with a basal-bolus insulin regimen where regular human insulin was used before each meal. Insulin glargine was administered once daily at bedtime and NPH insulin was administered once or twice

daily. The average age was 11.7 years. The majority of patients were White (97%) and 52% were male. The mean BMI was approximately 18.9 kg/m². The mean duration of diabetes was 5 years. Similar effects on HbA1c (Table 10) were observed in both treatment groups [see Adverse Reactions (6.1)].

Table 10: Type 1 Diabetes Mellitus - Pediatric Patients

Treatment duration Treatment in combination with	Study D 28 weeks Regular insulin	
	Insulin Glargine + Regular insulin	NPH+ Regular insulin
Number of subjects treated	174	175
HbA1c		
Baseline mean	8.5	8.8
Change from baseline (adjusted mean)	+0.3	+0.3
Difference from NPH (adjusted mean)	0.0	
(95% CI)	(-0.2; +0.3)	
Basal insulin dose		
Baseline mean	19	19
Mean change from baseline	-1	+2
Total insulin dose		
Baseline mean	43	43
Mean change from baseline	+2	+3
Fasting blood glucose (mg/dL)		
Baseline mean	194	191
Mean change from baseline	-23	-12
Body weight (kg)		
Baseline mean	45.5	44.6
Mean change from baseline	2.2	2.5

14.3 Clinical Studies in Adults with Type 2 Diabetes

In a randomized, controlled clinical study (Study E), in 570 adults with type 2 diabetes, insulin glargine was evaluated for 52 weeks in combination with oral anti-diabetic medications (a sulfonylurea, metformin, acarbose, or combinations of these drugs). The average age was 60 years old. The majority of patients were White (93%) and 54% were male. The mean BMI was approximately 29.1 kg/m². The mean duration of diabetes was 10 years. Insulin glargine administered once daily at bedtime was as effective as NPH insulin administered once daily at bedtime in reducing HbA1c and fasting glucose (Table 11). The rate of severe symptomatic hypoglycemia was similar in insulin glargine and NPH insulin treated patients [see Adverse Reactions (6.1)].

In a randomized, controlled clinical study (Study F), in adult patients with type 2 diabetes not using oral antidiabetic medications (n = 518), a basal-bolus regimen of insulin glargine once daily at bedtime or NPH insulin administered once or twice daily was evaluated for 28 weeks. Regular human insulin was used before meals, as needed. The average age was 59 years. The majority of patients were White (81%) and 60% were male. The mean BMI was approximately 30.5 kg/m². The mean duration of diabetes was

14 years. Insulin glargine had similar effectiveness as either once- or twice-daily NPH insulin in reducing HbA1c and fasting glucose (Table 11) with a similar incidence of hypoglycemia [see Adverse Reactions (6.1)].

In a randomized, controlled clinical study (Study G), adult patients with type 2 diabetes were randomized to 5 years of treatment with once-daily insulin glargine or twice-daily NPH insulin. For patients not previously treated with insulin, the starting dosage of insulin glargine or NPH insulin was 10 units daily. Patients who were already treated with NPH insulin either continued on the same total daily NPH insulin dose or started insulin glargine at a dosage that was 80% of the total previous NPH insulin dosage. The primary endpoint for this study was a comparison of the progression of diabetic retinopathy by 3 or more steps on the Early Treatment Diabetic Retinopathy Study (ETDRS) scale. HbA1c change from baseline was a secondary endpoint. Similar glycemic control in the 2 treatment groups was desired in order to not confound the interpretation of the retinal data. Patients or study personnel used an algorithm to adjust the insulin glargine and NPH insulin dosages to a target fasting plasma glucose ≤ 100 mg/dL. After the insulin glargine or NPH insulin dosage was adjusted, other anti-diabetic agents, including premeal insulin were to be adjusted or added. The average age was 55 years. The majority of patients were White (85%) and 54% were male. The mean BMI was approximately 34.3 kg/m². The mean duration of diabetes was 11 years. The insulin glargine group had a smaller mean reduction from baseline in HbA1c compared to the NPH insulin group, which may be explained by the lower daily basal insulin doses in the insulin glargine group (Table 11). The incidences of severe symptomatic hypoglycemia were similar between groups [see Adverse Reactions (6.1)].

Table 11: Type 2 Diabetes Mellitus - Adults

Treatment duration Treatment in combination with	Study E 52 weeks Oral agents		Study F 28 weeks Regular insulin		Study G 5 years Regular insulin	
	Insulin Glargine	NPH	Insulin Glargine	NPH	Insulin Glargine	NPH
Number of subjects treated	289	281	259	259	513	504
HbA1c						
Baseline mean	9.0	8.9	8.6	8.5	8.4	8.3
Adjusted mean change from baseline	-0.5	-0.4	-0.4	-0.6	-0.6	-0.8
Insulin Glargine – NPH	-0.1		+0.2		+0.2	
95% CI for Treatment difference	(-0.3; +0.1)		(0.0; +0.4)		(+0.1; +0.4)	
Basal insulin dose*						
Baseline mean	14	15	44.1	45.5	39	44
Mean change from baseline	+12	+9	-1	+7	+23	+30
Total insulin dose*						
Baseline mean	14	15	64	67	48	53
Mean change from baseline	+12	+9	+10	+13	+41	+40
Fasting blood glucose (mg/dL)						
Baseline mean	179	180	164	166	190	180
Adj. mean change from baseline	-49	-46	-24	-22	-45	-44

Body weight (kg)						
Baseline mean	83.5	82.1	89.6	90.7	100	99
Adj. mean change from baseline	2.0	1.9	0.4	1.4	3.7	4.8

* In Study G, the baseline dose of basal or total insulin was the first available on-treatment dose prescribed during the study (on visit month 1.5)

14.4 Additional Clinical Studies in Adults with Diabetes Type 1 and Type 2

Different Timing of Insulin Glargine Administration in Diabetes Type 1 and Diabetes Type 2

The safety and efficacy of once daily insulin glargine administered either at pre-breakfast, pre-dinner, or at bedtime were evaluated in a randomized, controlled clinical study in adult patients with type 1 diabetes (Study H, n = 378). Patients were also treated with insulin lispro at mealtime. The average age was 41 years. All patients were White (100%) and 54% were male. The mean BMI was approximately 25.3 kg/m². The mean duration of diabetes was 17 years.

Insulin glargine administered at pre-breakfast or at pre-dinner (both once daily) resulted in similar reductions in HbA1c compared to that with bedtime administration (see Table 12). In these patients, data are available from 8-point home glucose monitoring. The maximum mean blood glucose was observed just prior to insulin glargine injection regardless of time of administration. In this study, 5% of patients in the insulin glargine-breakfast group discontinued treatment because of lack of efficacy. No patients in the other two groups (pre-dinner, bedtime) discontinued for this reason.

The safety and efficacy of once daily Insulin glargine administered pre-breakfast or at bedtime were also evaluated in a randomized, active-controlled clinical study (Study I, n = 697) in patients with type 2 diabetes not adequately controlled on oral anti-diabetic therapy. All patients in this study also received glimepiride 3 mg daily. The average age was 61 years. The majority of patients were White (97%) and 54% were male. The mean BMI was approximately 28.7 kg/m². The mean duration of diabetes was 10 years. Insulin glargine given before breakfast was at least as effective in lowering HbA1c as insulin glargine given at bedtime or NPH insulin given at bedtime (see Table 12).

Table 12: Study of Different Times of Once Daily Insulin Glargine Dosing in Type 1 (Study H) and Type 2 (Study I) Diabetes Mellitus

Treatment duration Treatment in combination with	Study H 24 weeks Insulin lispro			Study I 24 weeks Glimepiride		
	Insulin Glargine Before Breakfast	Insulin Glargine Before Dinner	Insulin Glargine Bedtime	Insulin Glargine Before Breakfast	Insulin Glargine Bedtime	NPH Bedtime
Number of subjects treated*	112	124	128	234	226	227
HbA1c						
Baseline mean	7.6	7.5	7.6	9.1	9.1	9.1
Mean change from baseline	-0.2	-0.1	0.0	-1.3	-1.0	-0.8

Basal insulin dose (Units)						
Baseline mean	22	23	21	19	20	19
Mean change from baseline	5	2	2	11	18	18
Total insulin dose (Units)						
Baseline mean	52	52	49	-	-	-
Mean change from baseline	2	3	2	-	-	-
Body weight (kg)						
Baseline mean	77.1	77.8	74.5	80.7	82	81
Mean change from baseline	0.7	0.1	0.4	3.9	3.7	2.9

* Intent-to-treat

Progression of Retinopathy Evaluation in adults with Diabetes Type 1 and Diabetes Type 2

Insulin glargine was compared to NPH insulin in a 5-year randomized clinical study that evaluated the progression of retinopathy as assessed with fundus photography using a grading protocol derived from the Early Treatment Diabetic Retinopathy Scale (ETDRS). Patients had type 2 diabetes (mean age 55 years) with no (86%) or mild (14%) retinopathy at baseline. Mean baseline HbA1c was 8.4%. The primary outcome was progression by 3 or more steps on the ETDRS scale at study endpoint. Patients with pre-specified post-baseline eye procedures (pan-retinal photocoagulation for proliferative or severe nonproliferative diabetic retinopathy, local photocoagulation for new vessels, and vitrectomy for diabetic retinopathy) were also considered as 3-step progressors regardless of actual change in ETDRS score from baseline. Retinopathy graders were blinded to treatment group assignment.

The results for the primary endpoint are shown in Table 13 for both the per-protocol and intent-to-treat populations and indicate similarity of insulin glargine to NPH in the progression of diabetic retinopathy as assessed by this outcome. In this study, the numbers of retinal adverse events reported for insulin glargine and NPH insulin treatment groups were similar for adult patients with type 1 and type 2 diabetes.

Table 13: Number (%) of Patients with 3 or More Step Progression on ETDRS Scale at Endpoint

	Insulin Glargine (%)	NPH (%)	Difference^{*,†} (SE)	95% CI for difference
Per-protocol	53/374 (14.2%)	57/363 (15.7%)	-2.0% (2.6%)	-7.0% to +3.1%
Intent-to-Treat	63/502 (12.5%)	71/487 (14.6%)	-2.1% (2.1%)	-6.3% to +2.1%

* Difference = Insulin Glargine - NPH

† Using a generalized linear model (SAS GENMOD) with treatment and baseline HbA1c strata (cutoff 9.0%) as the classified independent variables, and with binomial distribution and identity link function

The ORIGIN Study of Major Cardiovascular Outcomes in Patients with Established CV Disease or CV Risk Factors

The Outcome Reduction with Initial Glargine Intervention study (i.e., ORIGIN) was an open-label, randomized, 2-by-2, factorial design study. One intervention in ORIGIN compared the effect of insulin glargine to standard care on major adverse cardiovascular (CV) outcomes in 12,537 adults \geq 50 years of age with;

- Abnormal glucose levels (i.e., impaired fasting glucose [IFG] and/or impaired glucose tolerance [IGT]) or early type 2 diabetes mellitus and
- Established CV disease or CV risk factors at baseline.

The objective of the study was to demonstrate that insulin glargine use could significantly lower the risk of major CV outcomes compared to standard care. There were two coprimary composite CV endpoints.

- The first coprimary endpoint was the time to first occurrence of a major adverse CV event defined as the composite of CV death, nonfatal myocardial infarction and nonfatal stroke.
- The second coprimary endpoint was the time to the first occurrence of CV death or nonfatal myocardial infarction or nonfatal stroke or revascularization procedure or hospitalization for heart failure.

Patients were randomized to either insulin glargine (N = 6,264) titrated to a goal fasting plasma glucose of \leq 95 mg/dL or to standard care (N = 6,273). Anthropometric and disease characteristics were balanced at baseline. The mean age was 64 years and 8% of patients were 75 years of age or older. The majority of patients were male (65%). Fifty nine percent were Caucasian, 25% were Latin, 10% were Asian and 3% were Black. The median baseline BMI was 29 kg/m². Approximately 12% of patients had abnormal glucose levels (IGT and/or IFG) at baseline and 88% had type 2 diabetes. For patients with type 2 diabetes, 59% were treated with a single oral antidiabetic drug, 23% had known diabetes but were on no antidiabetic drug and 6% were newly diagnosed during the screening procedure. The mean HbA1c (SD) at baseline was 6.5% (1.0). Fifty-nine percent of patients had a prior CV event and 39% had documented coronary artery disease or other CV risk factors.

Vital status was available for 99.9% and 99.8% of patients randomized to insulin glargine and standard care respectively at end of study. The median duration of follow-up was 6.2 years (range: 8 days to 7.9 years). The mean HbA1c (SD) at the end of the study was 6.5% (1.1) and 6.8% (1.2) in the insulin glargine and standard care group respectively. The median dose of insulin glargine at end of study was 0.45 U/kg. Eighty-one percent of patients randomized to insulin glargine were using insulin glargine at end of the study. The mean change in body weight from baseline to the last treatment visit was 2.2 kg greater in the insulin glargine group than in the standard care group.

Overall, the incidence of major adverse CV outcomes was similar between groups (see Table 14). All-cause mortality was also similar between groups.

Table 14: Cardiovascular Outcomes in ORIGIN in Patients with Established CV Disease or CV Risk Factors - Time to First Event Analyses

	Insulin Glargine N = 6,264	Standard Care N = 6,273	Insulin Glargine vs Standard Care
	n (Events per 100 PY)	n (Events per 100 PY)	Hazard Ratio (95% CI)
Coprimary endpoints			

CV death, nonfatal myocardial infarction, or nonfatal stroke	1041 (2.9)	1013 (2.9)	1.02 (0.94, 1.11)
CV death, nonfatal myocardial infarction, nonfatal stroke, hospitalization for heart failure or revascularization procedure	1792 (5.5)	1727 (5.3)	1.04 (0.97, 1.11)
Components of coprimary endpoints			
CV death	580	576	1.00 (0.89, 1.13)
Myocardial Infarction (fatal or nonfatal)	336	326	1.03 (0.88, 1.19)
Stroke (fatal or nonfatal)	331	319	1.03 (0.89, 1.21)
Revascularizations	908	860	1.06 (0.96, 1.16)
Hospitalization for heart failure	310	343	0.90 (0.77, 1.05)

In the ORIGIN study, the overall incidence of cancer (all types combined) or death from cancer (Table 15) was similar between treatment groups.

Table 15: Cancer Outcomes in ORIGIN - Time to First Event Analyses

	Insulin Glargine N = 6,264	Standard Care N = 6,273	Insulin Glargine vs Standard Care
	n (Events per 100 PY)	n (Events per 100 PY)	Hazard Ratio (95% CI)
Cancer endpoints			
Any cancer event (new or recurrent)	559 (1.56)	561 (1.56)	0.99 (0.88, 1.11)
New cancer events	524 (1.46)	535 (1.49)	0.96 (0.85, 1.09)
Death due to Cancer	189 (0.51)	201 (0.54)	0.94 (0.77, 1.15)

16 HOW SUPPLIED/STORAGE AND HANDLING

16.1 How Supplied

SEMGLEE (insulin glargine-yfqn) injection is supplied as a clear and colorless solution containing 100 units/mL (U-100) available as follows:

SEMGLEE	NDCNumber	PackageSize
10 mL multiple-dose vial	83257-011-11	1 vial
3 mL single-patient-use prefilled pen	83257-012-31	1 pen
	83257-012-32	3 pens
	83257-012-33	5 pens

Additional Information about SEMGLEE:

- The SEMGLEE prefilled pen dials in 1-unit increments.
- Needles are not included in the packs.

BD[®] Ultra-Fine needles are compatible with this pen.

16.2 Storage

Dispense in the original sealed carton with the enclosed Instructions for Use.

Store unused SEMGLEE in a refrigerator between 2° to 8°C (36° to 46°F). Do not freeze. Discard SEMGLEE if it has been frozen. Protect SEMGLEE from direct heat and light.

Storage conditions are summarized in the following table:

	Not in-use (unopened) Refrigerated (2° to 8°C [36° to 46°F])	Not in-use (unopened) Room Temperature (up to 30°C [86°F])	In-use (opened) (see temperature below)
10 mL multiple-dose vial	Until expiration date	28 days	28 days Refrigerated or room temperature
3 mL single-patient-use prefilled pen	Until expiration date	28 days	28 days Room temperature only (Do not refrigerate)

17 PATIENT COUNSELING INFORMATION

Advise the patient to read the FDA-approved patient labeling (Patient Information and Instructions for Use). There are separate Instructions for Use for the vial and prefilled pen.

Never Share a SEMGLEE Prefilled Pen or Insulin Syringe Between Patients

Advise patients that they must never share a SEMGLEE prefilled pen with another person, even if the needle is changed. Advise patients using SEMGLEE vials not to re-use or share needles or insulin syringes with another person. Sharing carries a risk for transmission of blood-borne pathogens [see *Warnings and Precautions (5.1)*].

Hyperglycemia or Hypoglycemia

Inform patients that hypoglycemia is the most common adverse reaction with insulin. Inform patients of the symptoms of hypoglycemia (e.g., impaired ability to concentrate and react. This may present a risk in situations where these abilities are especially important, such as driving or operating other machinery. Advise patients who have frequent hypoglycemia or reduced or absent warning signs of hypoglycemia to use caution when driving or operating machinery [see *Warnings and Precautions (5.3)*].

Advise patients that changes in insulin regimen can predispose to hyperglycemia or hypoglycemia and that changes in insulin regimen should be made under close medical supervision [see *Warnings and Precautions (5.2)*].

Hypoglycemia Due to Medication Errors

Instruct patients to always check the insulin label before each injection to reduce the risk of a medication error [see *Warnings and Precautions (5.4)*].

Hypersensitivity Reactions

Advise patients that hypersensitivity reactions have occurred with insulin glargine products. Inform patients about the symptoms of hypersensitivity reactions [see *Warnings and Precautions (5.5)*].

BD is a registered trademark of Becton, Dickinson, and Company.

Manufactured by:

Biocon Biologics Inc.

245 Main St, 2nd Floor,

Cambridge, MA 02142 U.S.A

U.S. License No. 2324

Product of Malaysia

Patient Information

SEMGLEE® (Sehm-GLEE)
(insulin glargine-yfgn) injection for subcutaneous use
VIAL: 100 units/mL (U-100)

Do not share your syringes with other people, even if the needle has been changed. You may give other people a serious infection, or get a serious infection from them.

What is SEMGLEE?

SEMGLEE is a long-acting man-made insulin used to control high blood sugar in adults and children with diabetes mellitus. SEMGLEE is not for use to treat diabetic ketoacidosis

Who should not use SEMGLEE?

Do not use SEMGLEE if you:

- are having an episode of low blood sugar (hypoglycemia).
- have an allergy to insulin glargine products or any of the ingredients in SEMGLEE. See the end of this Patient Information leaflet for a complete list of ingredients in SEMGLEE.

What should I tell my healthcare provider before using SEMGLEE?

Before using SEMGLEE, tell your healthcare provider about all your medical conditions including if you:

- have liver or kidney problems.
- take other medicines, especially ones called TZDs (thiazolidinediones).
- have heart failure or other heart problems. If you have heart failure, it may get worse while you take TZDs with SEMGLEE.
- are pregnant, planning to become pregnant, or are breastfeeding. It is not known if SEMGLEE may harm your unborn baby or breastfeeding baby.

Tell your healthcare provider about all the medicines you take including prescription and over-the-counter medicines, vitamins, and herbal supplements.

Before you start using SEMGLEE, talk to your healthcare provider about low blood sugar and how to manage it.

How should I use SEMGLEE?

- Read the detailed **Instructions for Use** that come with your SEMGLEE insulin.
- Use SEMGLEE exactly as your healthcare provider tells you to. Your healthcare provider should tell you how much SEMGLEE to use and when to use it.
- Know the amount of SEMGLEE you use. **Do not** change the amount of SEMGLEE you use unless your healthcare provider tells you to.
- Check your insulin label each time you give your injection to make sure you are using the correct insulin.
- **Do not** re-use needles. Always use a new needle for each injection. Re-use of needles increases your risk of having blocked needles, which may cause you to get the wrong dose of SEMGLEE. Using a new needle for each injection lowers your risk of getting an infection.
- You may take SEMGLEE at any time during the day but you must take it at the same time every day.
- Only use SEMGLEE that is clear and colorless. If your SEMGLEE is cloudy or slightly colored, return it to your pharmacy for a replacement.
- SEMGLEE is injected under the skin (subcutaneously) of your upper legs (thighs), upper arms, or stomach area (abdomen).
- Do not use SEMGLEE in an insulin pump or inject SEMGLEE into your vein (intravenously).
- **Change (rotate) injection sites within the area you chose with each dose** to reduce your risk of getting lipodystrophy (pits in skin or thickened skin) and localized cutaneous amyloidosis (skin with lumps) at the injection sites.
 - **Do not** use the exact same spot for each injection.
 - **Do not** inject where the skin has pits, is thickened or has lumps.
 - **Do not** inject where the skin is tender, bruised, scaly or hard, or into scars or damaged skin.
- **Do not** mix SEMGLEE with any other type of insulin or liquid medicine. **Check your blood sugar levels.** Ask your healthcare provider what your blood sugar should be and when you should check your blood sugar levels.
Keep SEMGLEE and all medicines out of the reach of children.

Your dose of SEMGLEE may need to change because of:

- a change in level of physical activity or exercise, weight gain or loss, increased stress, illness, change in diet, or because of the medicines you take.

What should I avoid while using SEMGLEE?

While using SEMGLEE do not:

- drive or operate heavy machinery, until you know how SEMGLEE affects you.
- drink alcohol or use over-the-counter medicines that contain alcohol.

What are the possible side effects of SEMGLEE and other insulins?

SEMGLEE may cause serious side effects that can lead to death, including:

- **low blood sugar (hypoglycemia).** Signs and symptoms that may indicate low blood sugar include:
 - dizziness or light-headedness, sweating, confusion, headache, blurred vision, slurred speech, shakiness, fast heartbeat, anxiety, irritability or mood change, hunger.
- **severe allergic reaction (whole body reaction). Get medical help right away if you have any of these signs or symptoms of a severe allergic reaction:**
 - a rash over your whole body, trouble breathing, a fast heartbeat, or sweating.
- **low potassium in your blood (hypokalemia).**
- **heart failure.** Taking certain diabetes pills called TZDs (thiazolidinediones) with SEMGLEE may cause heart failure in some people. This can happen even if you have never had heart failure or heart problems before. If you already have heart failure it may get worse while you take TZDs with SEMGLEE. Your healthcare provider should monitor you closely while you are taking TZDs with SEMGLEE. Tell your healthcare provider if you have any new or worse symptoms of heart failure including:
 - shortness of breath, swelling of your ankles or feet, sudden weight gain.

Treatment with TZDs and SEMGLEE may need to be changed or stopped by your healthcare provider if you have new or worse heart failure.

Get emergency medical help if you have:

trouble breathing, shortness of breath, fast heartbeat, swelling of your face, tongue, or throat, sweating, extreme drowsiness, dizziness, confusion.

The most common side effects of SEMGLEE include:

- low blood sugar (hypoglycemia); weight gain; allergic reactions, including reactions at your injection site; skin thickening or pits at the injection site (lipodystrophy).

These are not all the possible side effects of SEMGLEE. Call your doctor for medical advice about side effects. You may report side effects to FDA at 1-800-FDA-1088.

General information about the safe and effective use of SEMGLEE.

Medicines are sometimes prescribed for purposes other than those listed in a Patient Information leaflet. **Do not** use SEMGLEE for a condition for which it was not prescribed. **Do not** give SEMGLEE to other people, even if they have the same symptoms that you have. It may harm them.

This Patient Information leaflet summarizes the most important information about SEMGLEE. If you would like more information, talk with your healthcare provider. You can ask your pharmacist or healthcare provider for information about SEMGLEE that is written for healthcare professionals.

What are the ingredients in SEMGLEE?

- **Active ingredient:** insulin glargine-yfgn
- **10 mL vial inactive ingredients:** glycerol, metacresol, polysorbate-20, zinc

chloride, and Water for Injection. Hydrochloric acid and sodium hydroxide may be added to adjust the pH.

For more information, call Biocon Biologics at 1-833-986-1468.

Manufactured by:

Biocon Biologics Inc.

245 Main St, 2nd Floor, Cambridge, MA 02142, U.S.A.

U.S. License No. 2324

Product of Malaysia

This Patient Information has been approved by the U.S. Food and Drug Administration
Revised: 07/2023

Instructions for Use

SEMGLEE® (Sehm-GLEE)

(insulin glargine-yfqn) injection, for subcutaneous use

VIAL: (100 Units/mL, U-100)

These Instructions for Use contain information on how to inject SEMGLEE using the vial. Read these Instructions for Use before you start taking SEMGLEE and each time you get a new SEMGLEE vial. There may be new information. This information does not take the place of talking to your healthcare provider about your medical condition or your treatment.

Do not share your SEMGLEE syringes with other people even if the needle has been changed. You may give other people a serious infection, or get a serious infection from them.

Supplies needed to give your injection:

- a SEMGLEE 10 mL vial
- a U-100 insulin syringe and needle
- 2 alcohol swabs
- 1 sharps container for throwing away used needles and syringes. See “**Disposing of used needles and syringes**” at the end of these instructions.

Preparing to inject SEMGLEE:

- Wash your hands with soap and water or clean your hands with alcohol.
- Check the SEMGLEE label to make sure you are taking the right type of insulin. This is especially important if you use more than 1 type of insulin.
- Check the SEMGLEE in the vial to make sure it is clear and colorless. **Do not** use SEMGLEE if it is colored or cloudy, or if you see particles in the solution.
- **Do not** use SEMGLEE after the expiration date stamped on the label or 28 days after you first use it.
- **Always use a syringe that is marked for U-100 insulin.** If you use a syringe other than a U-100 insulin syringe, you may get the wrong dose of SEMGLEE.
 - **Always use a new syringe and a needle for each injection to help prevent infections and prevent blocked needles.**

Step 1:

If you are using a new SEMGLEE vial, remove the protective cap. **Do not** remove the rubber stopper.



Step 2:

Wipe the top of the vial with an alcohol swab. You do not have to shake the vial of SEMGLEE before use.



Step 3:

Draw air into the syringe equal to your SEMGLEE dose. Put the needle through the rubber top of the vial and push the plunger to inject the air into the vial.

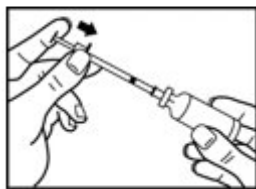

Step 4:

Leave the syringe in the vial and turn both upside down. Hold the syringe and vial firmly in one hand. Make sure the tip of the needle is in the SEMGLEE solution. With your free hand, pull the plunger to withdraw the correct dose into the syringe.

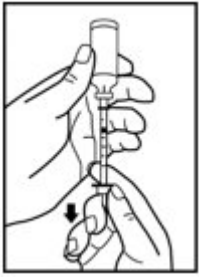

Step 5:

Before you take the needle out of the vial, check the syringe for air bubbles. If bubbles are in the syringe, hold the syringe straight up and tap the side of the syringe until the bubbles float to the top. Push the bubbles out with the plunger and draw insulin back in until you have the correct dose.

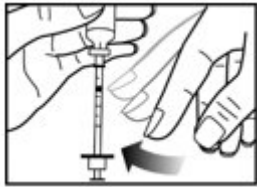

Step 6:

Remove the needle from the vial. Do not let the needle touch anything. You are now ready to inject.

Injecting SEMGLEE:

- Inject your SEMGLEE (with a syringe) exactly as your healthcare provider has shown you.
- SEMGLEE is injected once daily at any time of the day but at the same time every day.

Step 7:

Choose your injection site:

- SEMGLEE is injected under the skin (subcutaneously) of your upper arms, thighs, or stomach area (abdomen).
- **Change (rotate) your injection sites within the area you choose for each dose** to reduce your risk of getting lipodystrophy (pits in the skin or thickened skin) and localized cutaneous amyloidosis (skin with lumps) at the injection sites.
- **Do not** inject where the skin has pits, is thickened, or has lumps.
- **Do not** inject where the skin is tender, bruised, scaly or hard, or into scars or damaged skin.

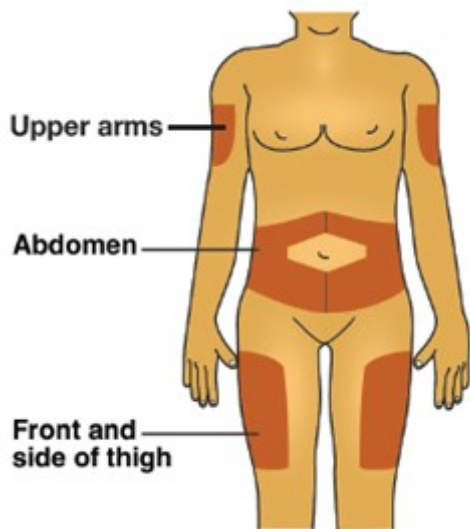

-
- **Wipe** the skin with an alcohol swab to clean the injection site. Let the injection site dry before you inject your dose.



Step 8:

- Pinch the skin.
- Insert the needle under the skin in the way your healthcare provider showed you.
- Release the skin
- Slowly push in the plunger of the syringe all the way, making sure you have injected all the SEMGLEE.
- Leave the needle in the skin for about **10** seconds.

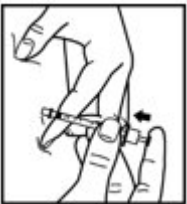

Step 9:

- Pull the needle straight out of your skin.
- Gently press the injection site for several seconds. **Do not** rub the area.
- **Do not** recap the used needle. Recapping the needle can lead to a needle stick injury.

Disposing of used needles and syringes:

- Put your used needles and syringes in a FDA-cleared sharps disposal container right away after use. **Do not** throw away (dispose of) loose needles and syringes in your household trash.
- If you do not have a FDA-cleared sharps container, you may use a household container that is:
 - o made of a heavy-duty plastic,
 - o can be closed with a tight-fitting, puncture-resistant lid, without sharps being able to come out,
 - o upright and stable during use,
 - o leak resistant, and
 - o properly labeled to warn of hazardous waste inside the container.
- When your sharps disposal container is almost full, you will need to follow your community guidelines for the right way to dispose of your sharps disposal container. There may be state or local laws about how you should throw away used needles and syringes. For more information about safe sharps disposal, and for specific information about sharps disposal in the state that you live in, go to the FDA's website at: <http://www.fda.gov/safesharpsdisposal>.
- **Do not** dispose of your used sharps disposal container in your household trash unless your community guidelines permit this. **Do not** recycle your used sharps disposal container.

Storing and Disposing SEMGLEE?

Unopened (not in-use) SEMGLEE vials

- Store unused SEMGLEE vials in the refrigerator at 36° to 46°F (2° to 8°C).
- **Do not** freeze SEMGLEE.
- Keep SEMGLEE out of direct heat and light.
- If a vial has been frozen or overheated, throw it away.
- Unopened vials can be used until the expiration date on the carton and vial label if they have been stored in the refrigerator (they can be stored past 28 days in the refrigerator).
- Unopened vials should be thrown away after 28 days if they are stored at room temperature.

After SEMGLEE vials have been opened (in-use)

- Store in-use (opened) SEMGLEE vials in a refrigerator from 36°F to 46°F (2°C to 8°C) or at room temperature below 86°F (30°C) for up to **28 days**.
- **Do not** freeze SEMGLEE. If a vial has to be frozen, throw it away.
- Keep SEMGLEE out of direct heat and light.
- The SEMGLEE vial you are using should be thrown away after **28** days or if the expiration date has passed, even if it still has insulin left in it.

This Instructions for Use has been approved by the U.S. Food and Drug Administration.
Revised: 07/2023

SEMGLEE® is a registered trademark of Biosimilars New Co Ltd; a Biocon Biologics Company.

Copyright © 2023 Biocon Biologics Inc. All rights reserved.

Manufactured by:
Biocon Biologics Inc.

245 Main St, 2nd Floor,
Cambridge, MA 02142 U.S.A.
U.S. License No. 2324
Product of Malaysia

Patient Information

SEMGLEE® (Sehm-GLEE)

(insulin glargine-yfgn) injection for subcutaneous use, 100 units/mL (U-100)

Do not share your SEMGLEE pen with other people, even if the needle has been changed. You may give other people a serious infection, or get a serious infection from them.

What is SEMGLEE?

SEMGLEE is a long-acting man-made insulin used to control high blood sugar in adults and children with diabetes mellitus. SEMGLEE is not for use to treat diabetic ketoacidosis.

Who should not use SEMGLEE?

Do not use SEMGLEE if you:

- are having an episode of low blood sugar (hypoglycemia).
- have an allergy to insulin glargine products or any of the ingredients in SEMGLEE. See the end of this Patient Information leaflet for a complete list of ingredients in SEMGLEE.

What should I tell my healthcare provider before using SEMGLEE?

Before using SEMGLEE, tell your healthcare provider about all your medical conditions including if you:

- have liver or kidney problems.
- take other medicines, especially ones called TZDs (thiazolidinediones).
- have heart failure or other heart problems. If you have heart failure, it may get worse while you take TZDs with SEMGLEE.
- are pregnant, planning to become pregnant, or are breastfeeding. It is not known if SEMGLEE may harm your unborn baby or breastfeeding baby.

Tell your healthcare provider about all the medicines you take including prescription and over-the-counter medicines, vitamins, and herbal supplements.

Before you start using SEMGLEE, talk to your healthcare provider about low blood sugar and how to manage it.

How should I use SEMGLEE?

- Read the detailed **Instructions for Use** that come with your SEMGLEE single-patient-use prefilled pen.
- Use SEMGLEE exactly as your healthcare provider tells you to. Your healthcare provider should tell you how much SEMGLEE to use and when to use it.
- Know the amount of SEMGLEE you use. **Do not** change the amount of SEMGLEE you use unless your healthcare provider tells you to.
- Check your insulin label each time you give your injection to make sure you are

using the correct insulin.

- The dose counter on your pen shows your dose of SEMGLEE. Do not make any dose changes unless your healthcare provider tells you to.
- **Do not** use a syringe to remove SEMGLEE from your disposable prefilled pen.
- **Do not** re-use needles. Always use a new needle for each injection. Re-use of needles increases your risk of having blocked needles, which may cause you to get the wrong dose of SEMGLEE. Using a new needle for each injection lowers your risk of getting an infection. If your needle is blocked, follow the instructions in **Step 3** of the **Instructions for Use**.
- You may take SEMGLEE at any time during the day but you must take it at the same time every day.
- SEMGLEE is injected under the skin (subcutaneously) of your upper legs (thighs), upper arms, or stomach area (abdomen).
- Do not use SEMGLEE in an insulin pump or inject SEMGLEE into your vein (intravenously).
- **Change (rotate) your injection sites within area you chose with each dose** to reduce your risk of getting lipodystrophy (pits in skin or thickened skin) and localized cutaneous amyloidosis (skin with lumps) at the injection sites.
 - **Do not** use the exact same spot for each injection.
 - **Do not** inject where the skin has pits, is thickened, or has lumps.
 - **Do not** inject where skin is tender, bruised, scaly or hard, or into scars or damaged skin.
- **Do not** mix SEMGLEE with any other type of insulin or liquid medicine.
- **Check your blood sugar levels.** Ask your healthcare provider what your blood sugar should be and when you should check your blood sugar levels.

Keep SEMGLEE and all medicines out of the reach of children.

Your dose of SEMGLEE may need to change because of:

- a change in level of physical activity or exercise, weight gain or loss, increased stress, illness, change in diet, or because of the medicines you take.

What should I avoid while using SEMGLEE?

While using SEMGLEE do not:

- drive or operate heavy machinery, until you know how SEMGLEE affects you.
- drink alcohol or use over-the-counter medicines that contain alcohol.

What are the possible side effects of SEMGLEE and other insulins?

SEMGLEE may cause serious side effects that can lead to death, including:

- **low blood sugar (hypoglycemia).** Signs and symptoms that may indicate low blood sugar include:
 - dizziness or light-headedness, sweating, confusion, headache, blurred vision, slurred speech, shakiness, fast heartbeat, anxiety, irritability or mood change, hunger.
- **severe allergic reaction (whole body reaction).** Get medical help right away if you have any of these signs or symptoms of a severe allergic

reaction:

- o a rash over your whole body, trouble breathing, a fast heartbeat, or sweating.

- **low potassium in your blood (hypokalemia).**
- **heart failure.** Taking certain diabetes pills called TZDs (thiazolidinediones) with SEMGLEE may cause heart failure in some people. This can happen even if you have never had heart failure or heart problems before. If you already have heart failure it may get worse while you take TZDs with SEMGLEE. Your healthcare provider should monitor you closely while you are taking TZDs with SEMGLEE. Tell your healthcare provider if you have any new or worse symptoms of heart failure including:

- o shortness of breath, swelling of your ankles or feet, sudden weight gain.

Treatment with TZDs and SEMGLEE may need to be changed or stopped by your healthcare provider if you have new or worse heart failure.

Get emergency medical help if you have:

trouble breathing, shortness of breath, fast heartbeat, swelling of your face, tongue, or throat, sweating, extreme drowsiness, dizziness, confusion.

The most common side effects of SEMGLEE include:

- low blood sugar (hypoglycemia); weight gain; allergic reactions, including reactions at your injection site; skin thickening or pits at the injection site (lipodystrophy).

These are not all the possible side effects of SEMGLEE. Call your doctor for medical advice about side effects. You may report side effects to FDA at 1-800-FDA-1088.

General information about the safe and effective use of SEMGLEE.

Medicines are sometimes prescribed for purposes other than those listed in a Patient Information leaflet. **Do not** use SEMGLEE for a condition for which it was not prescribed. **Do not** give SEMGLEE to other people, even if they have the same symptoms that you have. It may harm them.

This Patient Information leaflet summarizes the most important information about SEMGLEE. If you would like more information, talk with your healthcare provider. You can ask your healthcare provider or pharmacist for information about SEMGLEE that is written for healthcare professionals.

What are the ingredients in SEMGLEE?

- **Active ingredient:** insulin glargine-yfgn
- **3 mL prefilled pen inactive ingredients:** glycerol, metacresol, zinc chloride and Water for Injection. Hydrochloric acid and sodium hydroxide may be added to adjust the pH.

For more information, call Biocon Biologics at 1-833-986-1468.

Manufactured by: Biocon Biologics Inc.

245 Main St, 2nd Floor, Cambridge, MA 02142, U.S.A.

U.S. License No. 2324

Product of Malaysia

Revised: 07/2023

SEMGLEE® is a registered trademark of Biosimilars New Co Ltd; a Biocon Biologics Company. Copyright © 2023 Biocon Biologics Inc. All rights reserved.

Manufactured by:

Biocon Biologics Inc.

245 Main St, 2nd Floor,

Cambridge, MA 02142, U.S.A.

U.S. License No. 2324

Product of Malaysia

INSTRUCTIONS FOR USE

SEMGLEE® (Sehm-GLEE)

(insulin glargine-yfgn)

injection, for subcutaneous use

3 mL Single-Patient-Use PREFILLED PEN: 100 units/mL (U-100)

Read these Instructions for Use before you start taking the SEMGLEE pen and each time you get a new SEMGLEE pen. There may be new information. This information does not take the place of talking to your healthcare provider about your medical condition or your treatment. .

Do not share your SEMGLEE pen with other people, even if the needle has been changed. You may give other people a serious infection, or get a serious infection from them.

People who are blind or have vision problems should not use the SEMGLEE prefilled pen without help from a person trained to use the SEMGLEE prefilled pen.

SEMGLEE is a disposable prefilled pen used to inject SEMGLEE. Each SEMGLEE pen has 300 units of insulin which can be used for multiple injections. You can select doses from 1 to 80 units in steps of 1 unit. The pen plunger moves with each dose. The plunger will only move to the end of the cartridge when 300 units of SEMGLEE have been given.

Important Information You Need to Know Before Injecting SEMGLEE:

- **Do not** use your pen if it is damaged or if you are not sure that it is working properly.
- **Do not** use a syringe to remove SEMGLEE from your pen.
- **Do not reuse needles.** If you do, you might get the wrong dose of SEMGLEE and/or increase the chance of getting an infection.
- Always perform a safety test (see **Step 3**).
- Always carry a spare pen and spare needles in case they get lost or stop working.
- Change (rotate) your injection sites within the area you choose for each dose (see **“Places to Inject”**)

Learn to Inject

- Talk with your healthcare provider about how to inject before using your pen.
- Ask for help if you have problems handling the pen, for example if you have problems with your sight.
- Read all these instructions before using your pen. If you do not follow all these instructions, you may get too much or too little insulin.

Need Help?

If you have any questions about your pen or about diabetes, ask your healthcare provider, or call Biocon Biologics at 1-833-986-1468.

Extra Items You Will Need

- A new sterile needle (see **Step 2**).
- An alcohol swab.
- A puncture-resistant container for used needles and pens. (See “**Throwing your pen away**”)

Places to inject

- Inject your insulin exactly as your healthcare provider has shown you.
- Inject your insulin under the skin (subcutaneously) of your upper legs (thighs), upper arms, or stomach area (abdomen).
- Change (rotate) your injection sites within the area you choose for each dose to reduce your risk of getting lipodystrophy (pits in skin or thickened skin) and localized cutaneous amyloidosis (skin with lumps) at the injection sites.
- **Do not** inject where the skin has pits, is thickened, or has lumps.
- **Do not** inject where the skin is tender, bruised, scaly or hard, or into scars or damaged skin.

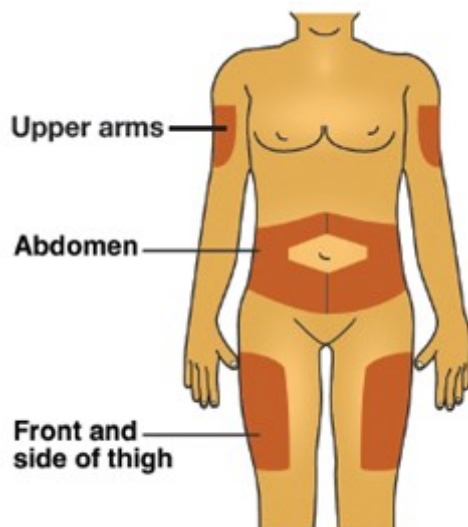

Get to know your pen

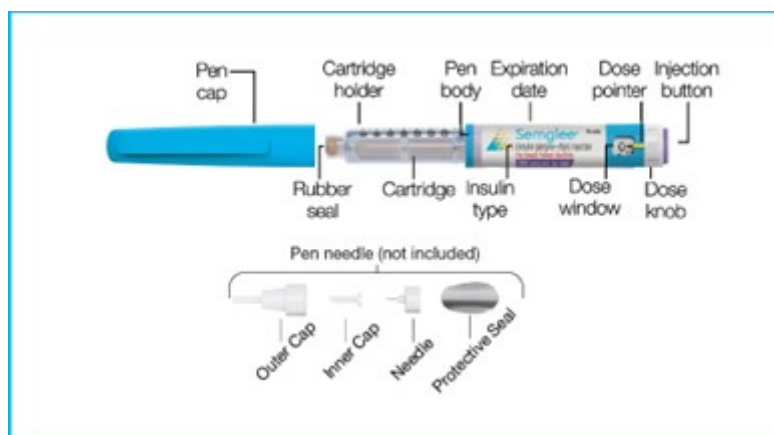

Step 1: Check your pen

Take a new pen out of the refrigerator at least 1 hour before you inject. Cold insulin is more painful to inject.

1A Check the name and expiration date on the label of your pen.

- Make sure you have the correct insulin (See Figure a).



- Do not use your pen after the expiration date (See Figure b).

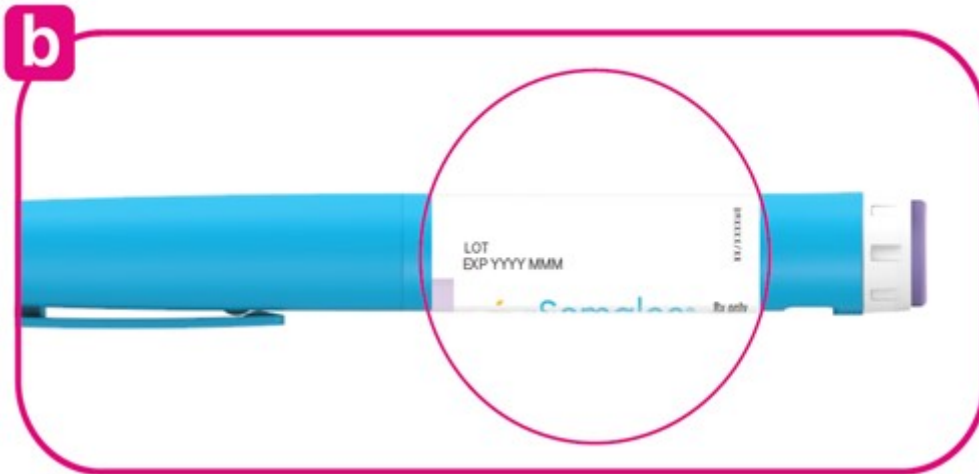

1B Pull off the pen cap (See Figure c).

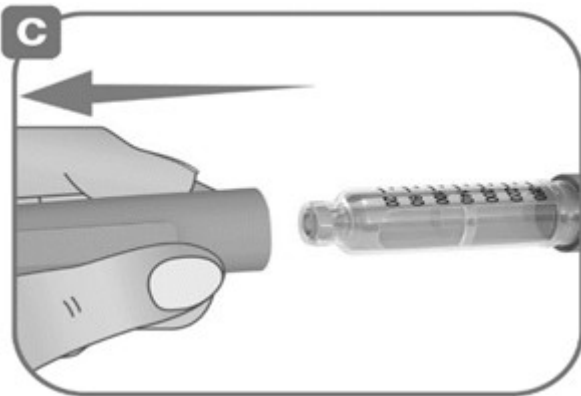

1C Check that the insulin is clear (See Figure d).

- **Do not** use the pen if the insulin looks cloudy, colored or contains particles.



1D Wipe the rubber seal with an alcohol swab (See Figure e).



If you have other injector pens:

- Making sure you have the correct medicine is especially important if you have other injector pens.

Step 2: Attach a new needle

- **Do not** reuse needles. Always use a new sterile needle for each injection. This helps stop blocked needles, contamination, and infection.

Only use needles that are compatible for use with SEMGLEE, such as BD Ultra Fine[®]

2A Take a new needle and peel off the protective seal (See Figure f).

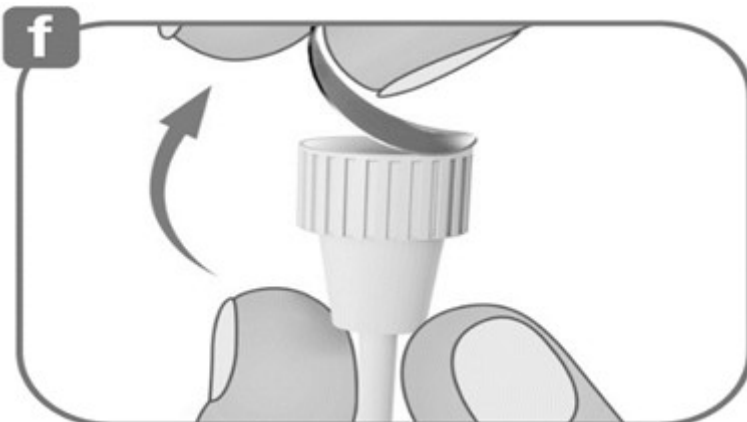

2B Keep the needle straight and screw it onto the pen until fixed. Do not

over-tighten (See Figure g).

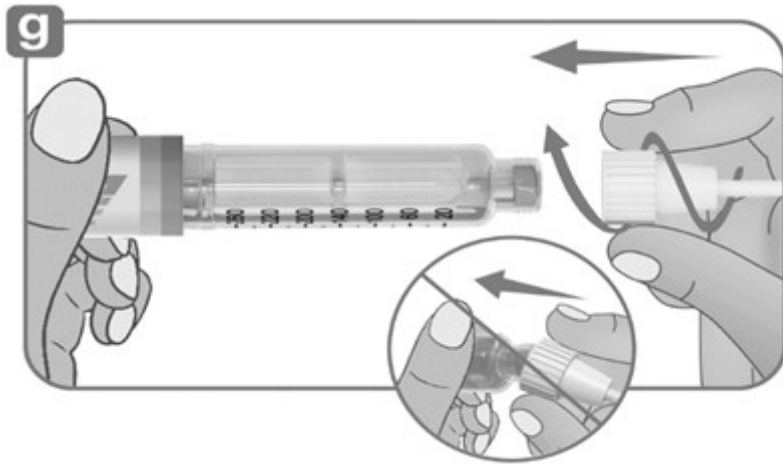

2C Pull off the outer needle cap (See Figure h). **Keep this for later.**



2D Pull off the inner needle cap and throw away (See Figure i).



Handling needles

- Take care when handling needles to prevent needle-stick injury and cross-infection.

Step 3: Do a safety test

Always do a safety test before each injection to:

- Check your pen and the needle to make sure they are working properly.

- Make sure that you get the correct SEMGLEE dose.

3A Select 2 units by turning the dose selector until the dose pointer is at the 2 mark (See Figure j).

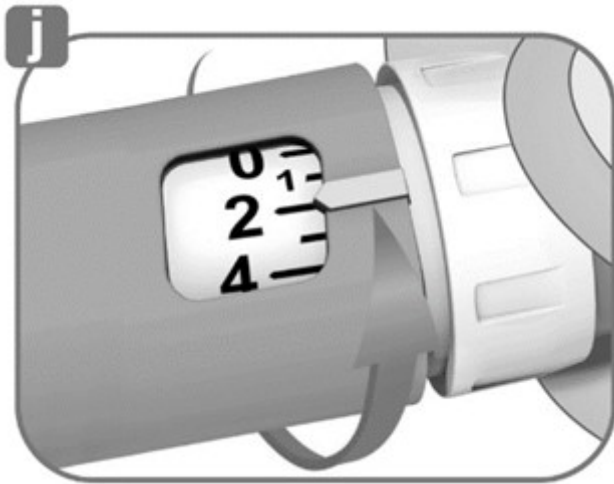

3B Press the injection button all the way in (See Figure k).

When insulin comes out of the needle tip, your pen is working correctly.

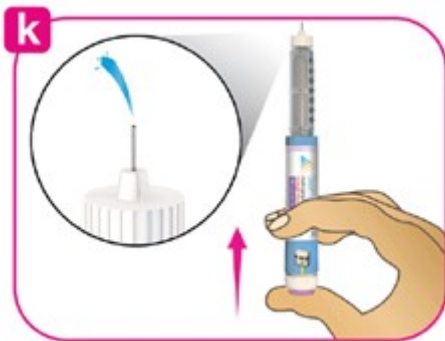

If no insulin appears:

- You may need to repeat this step up to 3 times before seeing insulin.
- If no insulin comes out after the third time, the needle may be blocked. If this happens:
 - change the needle (see **Step 6** and **Step 2**),
 - then repeat the safety test (**Step 3**).
- **Do not** use your pen if there is still no insulin coming out of the needle tip. Use a new pen.
- **Do not** use a syringe to remove insulin from your pen.

If you see air bubbles:

- You may see air bubbles in the insulin. This is normal, they will not harm you.

Step 4: Select the dose

Do not select a dose or press the injection button without a needle attached. This may damage your pen.

4A Make sure a needle is attached and the dose is set to “0” (See Figure l).



4B Turn the dose selector until the dose pointer lines up with your dose(See Figure m).

- If you turn past your dose, you can turn back down.
- If there are not enough units left in your pen for your dose, the dose selector will stop at the number of units left.
- If you cannot select your full prescribed dose, use a new pen or inject the remaining units and use a new pen to complete your dose.



How to read the dose window

Even numbers are shown in line with dose pointer (See Figure n).

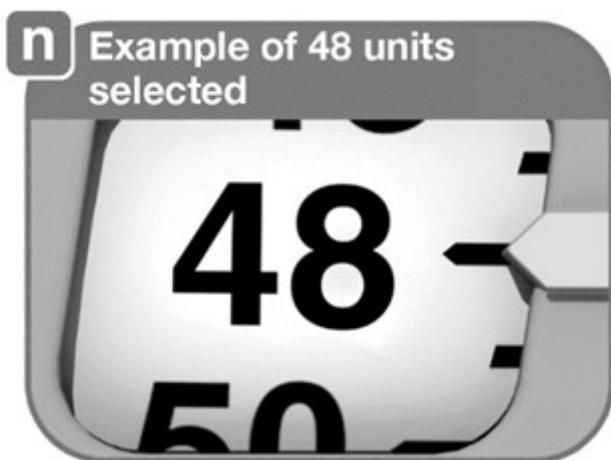

Odd numbers are shown as a line between even numbers (See Figure o).

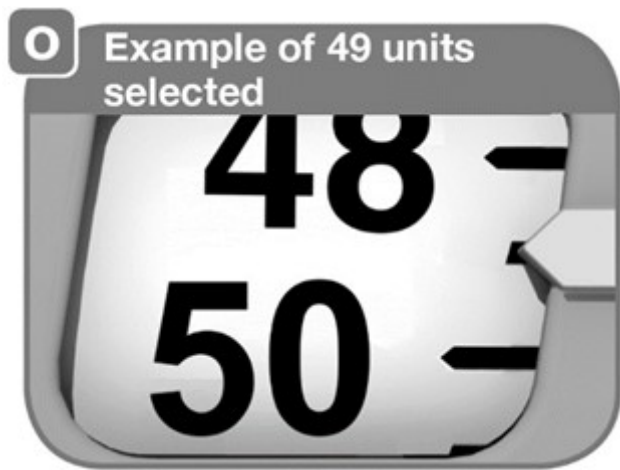

Units of SEMGLEE in your pen:

- Your pen contains a total of **300** units of SEMGLEE. You can select doses from **1** to **80** units in steps of **1** unit. Each pen contains more than 1 dose.
- You can see roughly how many units of insulin are left by looking at where the plunger is on the insulin scale.

Step 5: Injecting Your SEMGLEE Dose.

If you find it hard to press the injection button in, do not force it as this may break your pen. See the section below for help.

5A Choose a place to inject as shown in the section “Places to Inject”

5B Push the needle into your skin as shown by your healthcare provider (See Figure p).

Do not touch the injection button yet.

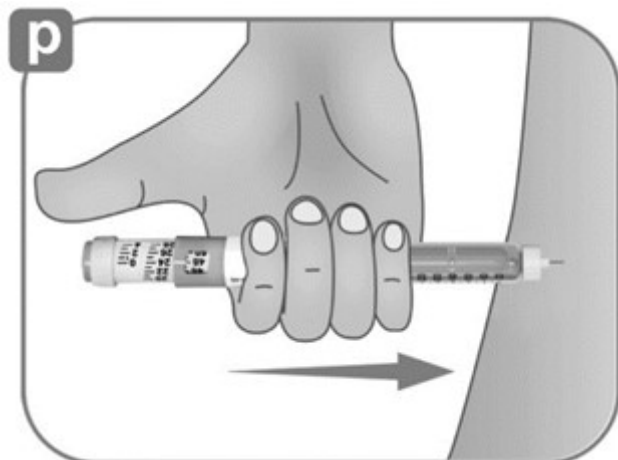

5C Place your thumb on the injection button. Then press all the way in and hold (See Figure q).

- **Do not** press at an angle. Your thumb could block the dose selector from turning.

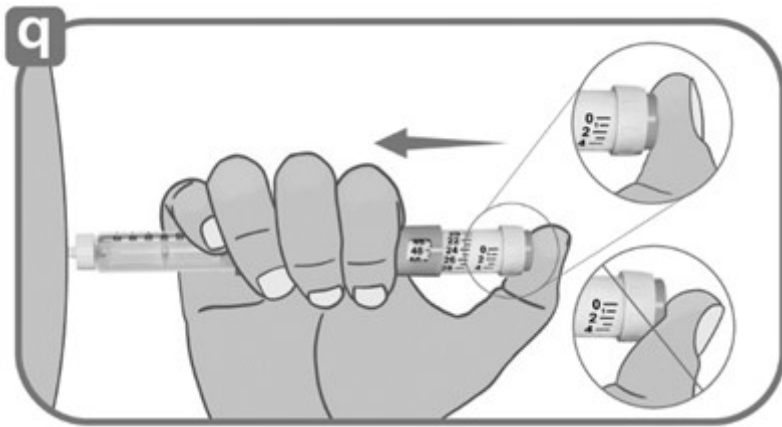

5D Keep the injection button held in and when you see “0” in the dose window, slowly count to 10 (See Figure r).

- This will make sure you get your full dose.

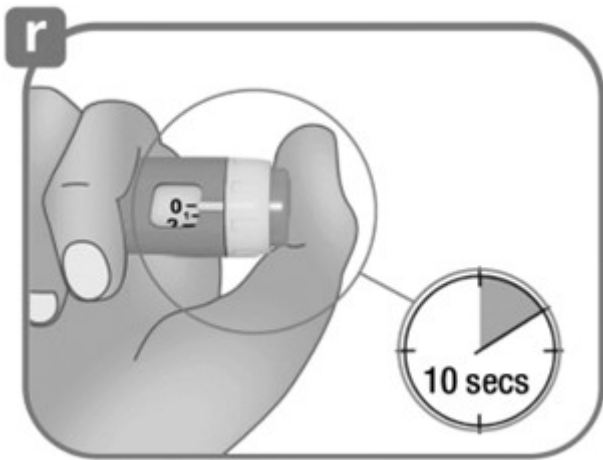

5E After holding and slowly counting to 10, release the injection button. Then remove the needle from your skin.

If you find it hard to press the button in:

- Change the needle (see **Step 6** and **Step 2**) then do a safety test (see **Step 3**).
- If you still find it hard to press in, get a new pen.
- **Do not** use a syringe to remove insulin from your pen.

Step 6: Remove the needle

- Take care when handling needles to prevent needle-stick injury and cross-infection.
- **Do not** put the inner needle cap back on.

6A Grip the widest part of the outer needle cap. Keep the needle straight and guide it into the outer needle cap. Then push firmly on (See Figure s).

- The needle can puncture the cap if it is recapped at an angle.

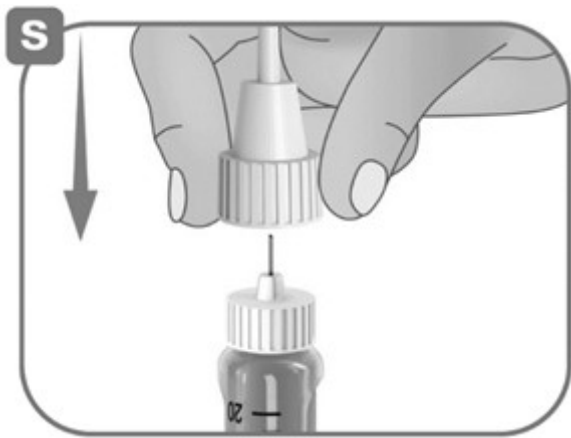

6B Grip and squeeze the widest part of the outer needle cap. Turn your pen several times with your other hand to remove the needle (See Figure t).

- Try again if the needle does not come off the first time.



6C Throw away the used needle in a puncture-resistant container (see “Throwing your pen away” at the end of this Instructions for Use). (See Figure u).



6D Put your pen cap back on (See Figure v).

- **Do not** put the pen back in the refrigerator.

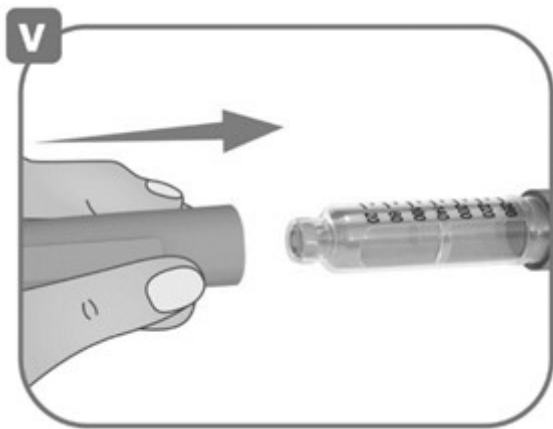

Storing the SEMGLEE Pen

Before first use:

- Keep new pens in the refrigerator between **36°F to 46°F (2°C to 8°C)**.
- **Do not** freeze. **Do not** use SEMGLEE if it has been frozen.

After first use:

- Keep your pen at room temperature below **86°F (30°C)**.
- Keep your pen away from heat or light.
- Store your pen with the pen cap on.
- **Do not** put your pen back in the refrigerator.
- **Do not** store your pen with the needle attached
- **Keep out of the reach of children.**
- Only use your pen for **up to 28 days** after its first use. Throw away the SEMGLEE pen you are using after 28 days, even if it still has insulin left in it.

Caring for Your SEMGLEE Pen

Handle your pen with care

- **Do not** drop your pen or knock it against hard surfaces.
- If you think that your pen may be damaged, **do not** try to fix it. Use a new one.

Protect your pen from dust and dirt

You can clean the outside of your pen by wiping it with a damp cloth (water only). **Do not** soak, wash or lubricate your pen. This may damage it.

Throwing your Pen away

- The used SEMGLEE pen may be thrown away in your household trash after you have removed the needle.
- Put the used needle in an FDA-cleared sharps disposal container right away after use. **Do not** throw away (dispose of) the used needles in your household trash.
- If you do not have an FDA-cleared sharps disposal container, you may use a household container that is:
 - made of a heavy-duty plastic,
 - can be closed with a tight-fitting, puncture-resistant lid, without sharps being able to come out,
 - upright and stable during use, leak-resistant, and properly labeled to warn of hazardous waste inside the container.
 - leak-resistant, and
 - properly labeled to warn of hazardous waste inside the container.

- When your sharps disposal container is almost full, you will need to follow your community guidelines for the right way to dispose of your sharps disposal container. There may be state or local laws about how you should throw away used needles and syringes. For more information about safe sharps disposal, and for specific information about sharps disposal in the state that you live in, go to the FDA's website at: <http://www.fda.gov/safesharpsdisposal>.

- **Do not** dispose of your used sharps disposal container in your household trash unless your community guidelines permit this. **Do not** recycle your used sharps disposal container.

This Instructions for Use has been approved by the U.S. Food and Drug Administration.

Revised: 07/2023

BD is a registered trademark of Becton, Dickinson, and Company.

SEMGLEE® is a registered trademark of Biosimilars New Co Ltd; a Biocon Biologics.

Copyright © 2023 Biocon Biologics Inc. All rights reserved

Manufactured by:

Biocon Biologics Inc.

245 Main St, 2nd Floor

Cambridge, MA 02142 U.S.A

U.S. License No. 2324

Product of Malaysia

PRINCIPAL DISPLAY PANEL - 100 units/mL Pen

NDC 83257-012-33

Rx only

Semglee®

(insulin glargine-yfgn) injection

For Single Patient Use Only

100 units/mL (U-100)

For subcutaneous use only

Dispense in this sealed carton

Do not mix with other insulins

Use only if solution is clear and colorless with no particles visible

***Needles not included** (see top panel)

Five 3 mL Prefilled Pens

Each mL contains 100 units of insulin glargine-yfgn, and inactive ingredients: glycerol (20 mg), metacresol (2.7 mg), zinc chloride (content adjusted to provide 30 mcg zinc ion), and Water for Injection, USP. The pH is approximately 4. The pH is adjusted by addition of aqueous solutions of hydrochloric acid and/or sodium hydroxide.

Recommended dosage: see Prescribing Information. As with any drug, if you are pregnant or nursing a baby, seek professional advice when using this product. Any change of insulin should be made cautiously and only under medical supervision.

Storage: Refrigerate at 2° to 8°C (36° to 46°F) until first use. Avoid freezing. Discard if frozen. After first use of a SEMGLEE pen, store the pen at room temperature (up to 30°C [86°F]) and discard after 28 days. Protect from direct heat and light.

WARNING: Keep this and all medication out of the reach of children.

Use within 28 days after initial use.

***BD® Ultra-Fine needles are compatible with Semglee®. These are sold separately and manufactured by BD.**

BD is a registered trademark of Becton, Dickinson, and Company.

SEMGLEE® is a registered trademark of Biosimilars New Co Ltd; a Biocon Biologics Company.

Copyright © 2023 Biocon Biologics Inc. All rights reserved.

Manufactured by:

Biocon Biologics Inc.

245 Main St, 2nd Floor,

Cambridge, MA 02142, U.S.A.

U.S. License No. 2324

Product of Malaysia



PRINCIPAL DISPLAY PANEL - 100 units/mL Vial
NDC 83257-011-11

Rx only

Semglee®
(insulin glargine-yfgn) injection
100 units/mL (U-100)

Do not mix with other insulins

Use only if solution is clear and colorless with no particles visible

For subcutaneous use only

Use with U-100 syringe only

One 10 mL
Multiple-Dose Vial

Each mL contains 100 units of insulin glargine-yfgn, and inactive ingredients: glycerol (20 mg), metacresol (2.7 mg), polysorbate-20 (20 mcg), zinc chloride (content adjusted to provide 30 mcg zinc ion), and Water for Injection, USP. The pH is approximately 4. The

pH is adjusted by addition of aqueous solutions of hydrochloric acid and/or sodium hydroxide.

Recommended dosage: see Prescribing Information. As with any drug, if you are pregnant or nursing a baby, seek professional advice when using this product. Any change of insulin should be made cautiously and only under medical supervision.

WARNING: Keep this and all medication out of the reach of children.

Storage: Refrigerate at 2° to 8°C (36° to 46°F) until first use. Avoid freezing. Discard if frozen.

After first use, store at room temperature (up to 30°C [86°F]) and discard after 28 days. Protect from direct heat and light.

SEMGLEE® is a registered trademark of Biosimilars New Co Ltd; a Biocon Biologics Company.

Copyright © 2023 Biocon Biologics Inc. All rights reserved.

Manufactured by:

Biocon Biologics Inc.

245 Main St, 2nd Floor,

Cambridge, MA 02142, U.S.A.

U.S. License No. 2324

Product of Malaysia



SEMGLEE

insulin glargine-yfgn injection, solution

Product Information

Product Type	HUMAN PRESCRIPTION DRUG	Item Code (Source)	NDC:83257-012
Route of Administration	SUBCUTANEOUS		

Active Ingredient/Active Moiety

Ingredient Name	Basis of Strength	Strength
INSULIN GLARGINE (UNII: 2Z M8CX04RZ) (INSULIN GLARGINE - UNII:2Z M8CX04RZ)	INSULIN GLARGINE	100 [iU] in 1 mL

Inactive Ingredients

Ingredient Name	Strength
ZINC CHLORIDE (UNII: 86Q357L16B)	30 ug in 1 mL
GLYCERIN (UNII: PDC6A3C0OX)	20 mg in 1 mL

METACRESOL (UNII: GGO4Y809LO)	2.7 mg in 1 mL
WATER (UNII: 059QF0K00R)	
HYDROCHLORIC ACID (UNII: QTT17582CB)	
SODIUM HYDROXIDE (UNII: 55X04QC32I)	

Packaging

#	Item Code	Package Description	Marketing Start Date	Marketing End Date
1	NDC:83257-012-31	1 in 1 CARTON	07/28/2023	
1		3 mL in 1 SYRINGE; Type 2: Prefilled Drug Delivery Device/System (syringe, patch, etc.)		
2	NDC:83257-012-32	3 in 1 CARTON	07/28/2023	
2		3 mL in 1 SYRINGE; Type 2: Prefilled Drug Delivery Device/System (syringe, patch, etc.)		
3	NDC:83257-012-33	5 in 1 CARTON	07/28/2023	
3		3 mL in 1 SYRINGE; Type 2: Prefilled Drug Delivery Device/System (syringe, patch, etc.)		

Marketing Information

Marketing Category	Application Number or Monograph Citation	Marketing Start Date	Marketing End Date
BLA	BLA761201	07/28/2023	

SEMGLEE

insulin glargine-yfgn injection, solution

Product Information

Product Type	HUMAN PRESCRIPTION DRUG	Item Code (Source)	NDC:83257-011
Route of Administration	SUBCUTANEOUS		

Active Ingredient/Active Moiety

Ingredient Name	Basis of Strength	Strength
INSULIN GLARGINE (UNII: 2Z M8CX04RZ) (INSULIN GLARGINE - UNII:2Z M8CX04RZ)	INSULIN GLARGINE	100 [iU] in 1 mL

Inactive Ingredients

Ingredient Name	Strength
ZINC CHLORIDE (UNII: 86Q357L16B)	30 ug in 1 mL
GLYCERIN (UNII: PDC6A3C00X)	20 mg in 1 mL
POLYSORBATE 20 (UNII: 7T1F30V5YH)	20 ug in 1 mL
METACRESOL (UNII: GGO4Y809LO)	2.7 mg in 1 mL

WATER (UNII: 059QF0KOOR)	
HYDROCHLORIC ACID (UNII: QTT17582CB)	
SODIUM HYDROXIDE (UNII: 55X04QC32I)	

Packaging				
#	Item Code	Package Description	Marketing Start Date	Marketing End Date
1	NDC:83257-011-11	1 in 1 CARTON	07/28/2023	
1		10 mL in 1 VIAL, MULTI-DOSE; Type 2: Prefilled Drug Delivery Device/System (syringe, patch, etc.)		

Marketing Information			
Marketing Category	Application Number or Monograph Citation	Marketing Start Date	Marketing End Date
BLA	BLA761201	07/28/2023	

Labeler - Biocon Biologics Inc. (117609395)

Establishment			
Name	Address	ID/FEI	Business Operations
BIOCON SDN.BHD.		865785591	manufacture(83257-012, 83257-011) , analysis(83257-012, 83257-011) , pack(83257-012, 83257-011)

Revised: 7/2023

Biocon Biologics Inc.