

DICLOFENAC SODIUM- diclofenac sodium gel

Padagis Israel Pharmaceuticals Ltd

HIGHLIGHTS OF PRESCRIBING INFORMATION

These highlights do not include all the information needed to use DICLOFENAC SODIUM TOPICAL GEL safely and effectively. See full prescribing information for DICLOFENAC SODIUM TOPICAL GEL.

DICLOFENAC SODIUM topical gel, 1%, for topical use only

Initial U.S. Approval: 1988

WARNING: RISK OF SERIOUS CARDIOVASCULAR AND GASTROINTESTINAL EVENTS

See full prescribing information for complete boxed warning.

- **Nonsteroidal anti-inflammatory drugs (NSAIDs) cause an increased risk of serious cardiovascular thrombotic events, including myocardial infarction and stroke, which can be fatal. This risk may occur early in treatment and may increase with duration of use. (5.1)**
- **Diclofenac Sodium Topical Gel is contraindicated in the setting of coronary artery bypass graft (CABG) surgery. (4, 5.1)**
- **NSAIDs cause an increased risk of serious gastrointestinal (GI) adverse events including bleeding, ulceration, and perforation of the stomach or intestines, which can be fatal. These events can occur at any time during use and without warning symptoms. Elderly patients and patients with a prior history of peptic ulcer disease and/or GI bleeding are at greater risk for serious GI events. (5.2)**

Diclofenac Sodium Topical Gel is contraindicated in the setting of coronary artery bypass graft (CABG) surgery. (4, 5.1)

NSAIDs cause an increased risk of serious gastrointestinal (GI) adverse events including bleeding, ulceration, and perforation of the stomach or intestines, which can be fatal. These events can occur at any time during use and without warning symptoms. Elderly patients and patients with a prior history of peptic ulcer disease and/or GI bleeding are at greater risk for serious GI events. (5.2)

----- INDICATIONS AND USAGE -----

Diclofenac Sodium Topical Gel is a non-steroidal anti-inflammatory drug indicated for the relief of the pain of osteoarthritis of joints amenable to topical treatment, such as the knees and those of the hands. (1)

- Diclofenac Sodium Topical Gel was not evaluated for use on joints of the spine, hip, or shoulder. (14.1)

----- DOSAGE AND ADMINISTRATION -----

- Use the lowest effective dosage for shortest duration consistent with individual patient treatment goals. (2.1)
- Lower extremities: Apply the gel (4 g) to the affected area 4 times daily. Do not apply more than 16 g daily to any one affected joint of the lower extremities. (2.2) (2)
- Upper extremities: Apply the gel (2 g) to the affected area 4 times daily. Do not apply more than 8 g daily to any one affected joint of the upper extremities. (2.3) (2)
- Total dose should not exceed 32 g per day, over all affected joints. (2.3)
Diclofenac Sodium Topical Gel should be measured onto the enclosed dosing card to the appropriate 2 g or 4 g designation. (2) (2)

----- DOSAGE FORMS AND STRENGTHS -----

- Diclofenac Sodium Topical Gel, 1% (3)

----- CONTRAINDICATIONS -----

- Known hypersensitivity to diclofenac or any components of the drug product. (4)
- History of asthma, urticaria, or other allergic-type reactions after taking aspirin or other NSAIDs. (4)
- In the setting of CABG surgery. (4)

----- WARNINGS AND PRECAUTIONS -----

- Hepatotoxicity: Inform patients of warning signs and symptoms of hepatotoxicity. Discontinue if abnormal liver tests persist or worsen or if clinical signs and symptoms of liver disease develop (5.3)
- Hypertension: Patients taking some antihypertensive medications may have impaired response to these therapies when taking NSAIDs. Monitor blood pressure (5.4, 7)
- Heart Failure and Edema: Avoid use of Diclofenac Sodium Topical Gel in patients with severe heart failure unless benefits are expected to outweigh risk of worsening heart failure (5.5)
- Renal Toxicity: Monitor renal function in patients with renal or hepatic impairment, heart failure, dehydration, or hypovolemia. Avoid use of Diclofenac Sodium Topical Gel in patients with advanced renal disease unless benefits are expected to outweigh risk of worsening renal function (5.6)
- Anaphylactic Reactions: Seek emergency help if an anaphylactic reaction occurs (5.7)
- Exacerbation of Asthma Related to Aspirin Sensitivity: Diclofenac Sodium Topical Gel is contraindicated in patients with aspirin-sensitive asthma. Monitor patients with preexisting asthma (without aspirin sensitivity) (5.8)
- Serious Skin Reactions: Discontinue Diclofenac Sodium Topical Gel at first appearance of rash or other signs of hypersensitivity (5.9)
- Premature Closure of Fetal Ductus Arteriosus: Avoid use in pregnant women starting at 30 weeks gestation (5.10, 8.1)
- Hematologic Toxicity: Monitor hemoglobin or hematocrit in patients with any signs or symptoms of anemia (5.11, 7)

----- ADVERSE REACTIONS -----

Most common adverse reactions (incidence >2% of patients treated with diclofenac sodium topical gel and greater than placebo) are application site reactions, including dermatitis. (6.1)

To report SUSPECTED ADVERSE REACTIONS, contact Perrigo at 1-866-634-9120 or FDA at 1-800-FDA-1088 or www.fda.gov/medwatch.

----- DRUG INTERACTIONS -----

- Drugs that Interfere with Hemostasis (e.g. warfarin, aspirin, SSRIs/SNRIs): Monitor patients for bleeding who are concomitantly using Diclofenac Sodium Topical Gel with drugs that interfere with hemostasis. Concomitant use of Diclofenac Sodium Topical Gel and analgesic doses of aspirin is not generally recommended (7)
- ACE Inhibitors, Angiotensin Receptor Blockers (ARB), or Beta-Blockers: Concomitant use with Diclofenac Sodium Topical Gel may diminish the antihypertensive effect of these drugs. Monitor blood pressure (7)
- ACE Inhibitors and ARBs: Concomitant use with Diclofenac Sodium Topical Gel in elderly, volume depleted, or those with renal impairment may result in deterioration of renal function. In such high risk patients, monitor for signs of worsening renal function (7)
- Diuretics: NSAIDs can reduce natriuretic effect of furosemide and thiazide diuretics. Monitor patients to assure diuretic efficacy including antihypertensive effects (7)
- Digoxin: Concomitant use with Diclofenac Sodium Topical Gel can increase serum concentration and prolong half-life of digoxin. Monitor serum digoxin levels (7)

----- USE IN SPECIFIC POPULATIONS -----

Pregnancy: Use of NSAIDs during the third trimester of pregnancy increases the risk of premature closure of the fetal ductus arteriosus. Avoid use of NSAIDs in pregnant women starting at 30 weeks gestation. (5.10, 8.1) (8)

Infertility: NSAIDs are associated with reversible infertility. Consider withdrawal of (8) Diclofenac Sodium Topical Gel in women who have difficulties conceiving. (8.3) (8)

See 17 for PATIENT COUNSELING INFORMATION and Medication Guide.

Revised: 4/2022

FULL PRESCRIBING INFORMATION: CONTENTS*

WARNING: RISK OF SERIOUS CARDIOVASCULAR AND GASTROINTESTINAL EVENTS

1 INDICATIONS AND USAGE

2 DOSAGE AND ADMINISTRATION

- 2.1 Dosing Card
- 2.2 Lower Extremities
- 2.3 Upper Extremities
- 2.4 Special Precautions

3 DOSAGE FORM AND STRENGTH

4 CONTRAINDICATIONS

5 WARNINGS AND PRECAUTIONS

- 5.1 Cardiovascular Thrombotic Events
- 5.2 Gastrointestinal Bleeding, Ulceration, and Perforation
- 5.3 Hepatotoxicity
- 5.4 Hypertension
- 5.5 Heart Failure and Edema
- 5.6 Renal Toxicity and Hyperkalemia
- 5.7 Anaphylactic Reactions
- 5.8 Exacerbation of Asthma Related to Aspirin Sensitivity
- 5.9 Serious Skin Reactions
- 5.10 Premature Closure of Fetal Ductus Arteriosus
- 5.11 Hematologic Toxicity
- 5.12 Masking of Inflammation and Fever
- 5.13 Laboratory Monitoring
- 5.14 Sun Exposure
- 5.15 Eye Exposure
- 5.16 Oral Nonsteroidal Anti-inflammatory Drugs

6 ADVERSE REACTIONS

- 6.1 Clinical Trials Experience

7 DRUG INTERACTIONS

8 USE IN SPECIFIC POPULATIONS

- 8.1 Pregnancy
- 8.2 Lactation
- 8.3 Females and Males of Reproductive Potential
- 8.4 Pediatric Use
- 8.5 Geriatric Use

10 OVERDOSAGE

11 DESCRIPTION

12 CLINICAL PHARMACOLOGY

- 12.1 Mechanism of Action
- 12.3 Pharmacokinetics

13 NONCLINICAL TOXICOLOGY

- 13.1 Carcinogenesis, Mutagenesis, Impairment of Fertility

14 CLINICAL STUDIES

- 14.1 Pivotal Studies in Osteoarthritis of the Superficial Joints of the Extremities

16 HOW SUPPLIED/STORAGE AND HANDLING

17 PATIENT COUNSELING INFORMATION

* Sections or subsections omitted from the full prescribing information are not listed.

FULL PRESCRIBING INFORMATION

WARNING: RISK OF SERIOUS CARDIOVASCULAR AND GASTROINTESTINAL EVENTS

Cardiovascular Thrombotic Events

- **Nonsteroidal anti-inflammatory drugs (NSAIDs) cause an increased risk of serious cardiovascular thrombotic events, including myocardial infarction and stroke, which can be fatal. This risk may occur early in treatment and may increase with duration of use [see *Warnings and Precautions (5.1)*].**
- **Diclofenac Sodium Topical Gel is contraindicated in the setting of coronary artery bypass graft (CABG) surgery [see *Contraindications (4)* and *Warnings and Precautions (5.1)*].**

Diclofenac Sodium Topical Gel is contraindicated in the setting of coronary artery bypass graft (CABG) surgery [see *Contraindications (4)* and *Warnings and Precautions (5.1)*].

Gastrointestinal Bleeding, Ulceration, and Perforation

- **NSAIDs cause an increased risk of serious gastrointestinal (GI) adverse events including bleeding, ulceration, and perforation of the stomach or intestines, which can be fatal. These events can occur at any time during use and without warning symptoms. Elderly patients and patients with a prior history of peptic ulcer disease and/or GI bleeding are at greater risk for serious GI events [see *Warnings and Precautions (5.2)*].**

1 INDICATIONS AND USAGE

Diclofenac Sodium Topical Gel is indicated for the relief of the pain of osteoarthritis of joints amenable to topical treatment, such as the knees and those of the hands.

- Diclofenac Sodium Topical Gel has not been evaluated for use on the spine, hip, or shoulder.

2 DOSAGE AND ADMINISTRATION

Use the lowest effective dosage for the shortest duration consistent with individual patient treatment goals [see *Warnings and Precautions (5)*].

2.1 Dosing Card

The dosing card can be found attached to the inside of the carton.

The proper amount of Diclofenac Sodium Topical Gel should be measured using the dosing card supplied in the drug product carton. The dosing card is made of clear polypropylene. The dosing card should be used for each application of drug product.

The gel should be applied within the rectangular area of the dosing card up to the 2 gram or 4 gram line (2 g for each elbow, wrist, or hand, and 4 g for each knee, ankle, or foot). The 2 g line is 2.25 inches long. The 4 g line is 4.5 inches long.

The dosing card containing Diclofenac Sodium Topical Gel can be used to apply the gel. The hands should then be used to gently rub the gel into the skin. After using the dosing card, hold with fingertips, rinse, and dry. If treatment site is the hands, patients should wait at least one (1) hour to wash their hands.

2.2 Lower Extremities

Apply the gel (4 g) to the affected foot, ankle, or knee 4 times daily. Diclofenac Sodium Topical Gel should be gently massaged into the skin ensuring application to the entire affected foot, or knee or ankle. The entire foot includes the sole, top of the foot and the toes. Do not apply more than 16 g daily to any single joint of the lower extremities.

2.3 Upper Extremities

Apply the gel (2 g) to the affected hand, wrist, or elbow 4 times daily. Diclofenac Sodium Topical Gel should be gently massaged into the skin ensuring application to the entire affected hand, wrist, or elbow. The entire hand includes the palm, back of the hands, and the fingers. Do not apply more than 8 g daily to any single joint of the upper extremities.

Total dose should not exceed 32 g per day, over all affected joints.

2.4 Special Precautions

- Avoid showering/bathing for at least 1 hour after the application. Inform patient to wash his/her hands after use, unless the hands are the treated joint. If Diclofenac Sodium Topical Gel is applied to the hand(s) for treatment; inform patient not to wash the treated hand(s) for at least 1 hour after the application.
- Do not apply Diclofenac Sodium Topical Gel to open wounds.
- Avoid contact of Diclofenac Sodium Topical Gel with eyes and mucous membranes.
- Do not apply external heat and/or occlusive dressings to treated joints.
- Avoid exposure of the treated joint(s) to natural or artificial sunlight.
- Avoid concomitant use of Diclofenac Sodium Topical Gel on the treated skin site with other topical products, including sunscreens, cosmetics, lotions, moisturizers, insect repellants, or other topical medications.
- Concomitant use of Diclofenac Sodium Topical Gel with oral non-steroidal anti-inflammatory drugs (NSAIDs) has not been evaluated, and may increase adverse NSAIDs effects. Do not use combination therapy with Diclofenac Sodium Topical Gel and an oral NSAID unless the benefit outweighs the risk and conduct periodic laboratory evaluations.
- Avoid wearing of clothing or gloves for at least 10 minutes after applying Diclofenac Sodium Topical Gel.

3 DOSAGE FORM AND STRENGTH

Diclofenac Sodium Topical Gel, 1%

4 CONTRAINDICATIONS

Diclofenac Sodium Topical Gel is contraindicated in the following patients:

- Known hypersensitivity (e.g., anaphylactic reactions and serious skin reactions) to diclofenac or any components of the drug product [see *Warnings and Precautions* (5.7, 5.9)]
- History of asthma, urticaria, or other allergic-type reactions after taking aspirin or other NSAIDs. Severe, sometimes fatal, anaphylactic reactions to NSAIDs have been reported in such patients [see *Warnings and Precautions* (5.7, 5.8)]
- In the setting of coronary artery bypass graft (CABG) surgery [see *Warnings and Precautions* (5.1)]

5 WARNINGS AND PRECAUTIONS

5.1 Cardiovascular Thrombotic Events

Clinical trials of several COX-2 selective and nonselective NSAIDs of up to three years duration have shown an increased risk of serious cardiovascular (CV) thrombotic events, including myocardial infarction (MI) and stroke, which can be fatal. Based on available data, it is unclear that the risk for CV thrombotic events is similar for all NSAIDs. The relative increase in serious CV thrombotic events over baseline conferred by NSAID use appears to be similar in those with and without known CV disease or risk factors for CV disease. However, patients with known CV disease or risk factors had a higher absolute incidence of excess serious CV thrombotic events, due to their increased baseline rate. Some observational studies found that this increased risk of serious CV thrombotic events began as early as the first weeks of treatment. The increase in CV thrombotic risk has been observed most consistently at higher doses.

To minimize the potential risk for an adverse CV event in NSAID-treated patients, use the lowest effective dose for the shortest duration possible. Physicians and patients should remain alert for the development of such events, throughout the entire treatment course, even in the absence of previous CV symptoms. Patients should be informed about the symptoms of serious CV events and the steps to take if they occur.

There is no consistent evidence that concurrent use of aspirin mitigates the increased risk of serious CV thrombotic events associated with NSAID use. The concurrent use of aspirin and an NSAID, such as diclofenac, increases the risk of serious gastrointestinal (GI) events [see *Warnings and Precautions* (5.2)].

Status Post Coronary Artery Bypass Graft (CABG) Surgery

Two large, controlled clinical trials of a COX-2 selective NSAID for the treatment of pain in the first 10-14 days following CABG surgery found an increased incidence of myocardial infarction and stroke. NSAIDs are contraindicated in the setting of CABG [see *Contraindications* (4)].

Post-MI Patients

Observational studies conducted in the Danish National Registry have demonstrated that patients treated with NSAIDs in the post-MI period were at increased risk of reinfarction, CV-related death, and all-cause mortality beginning in the first week of treatment. In this same cohort, the incidence of death in the first year post-MI was 20 per 100 person

years in NSAID-treated patients compared to 12 per 100 person years in non-NSAID exposed patients. Although the absolute rate of death declined somewhat after the first year post-MI, the increased relative risk of death in NSAID users persisted over at least the next four years of follow-up.

Avoid the use of Diclofenac Sodium Topical Gel in patients with a recent MI unless the benefits are expected to outweigh the risk of recurrent CV thrombotic events. If Diclofenac Sodium Topical Gel is used in patients with a recent MI, monitor patients for signs of cardiac ischemia.

5.2 Gastrointestinal Bleeding, Ulceration, and Perforation

NSAIDs, including diclofenac, cause serious gastrointestinal (GI) adverse events including inflammation, bleeding, ulceration, and perforation of the esophagus, stomach, small intestine, or large intestine, which can be fatal. These serious adverse events can occur at any time, with or without warning symptoms, in patients treated with NSAIDs. Only one in five patients who develop a serious upper GI adverse event on NSAID therapy is symptomatic. Upper GI ulcers, gross bleeding, or perforation caused by NSAIDs occurred in approximately 1% of patients treated for 3-6 months, and in about 2%-4% of patients treated for one year. However, even short-term NSAID therapy is not without risk.

Risk Factors for GI Bleeding, Ulceration, and Perforation

Patients with a prior history of peptic ulcer disease and/or GI bleeding who used NSAIDs had a greater than 10-fold increased risk for developing a GI bleed compared to patients without these risk factors. Other factors that increase the risk of GI bleeding in patients treated with NSAIDs include longer duration of NSAID therapy; concomitant use of oral corticosteroids, aspirin, anticoagulants, or selective serotonin reuptake inhibitors (SSRIs); smoking; use of alcohol; older age; and poor general health status. Most postmarketing reports of fatal GI events occurred in elderly or debilitated patients. Additionally, patients with advanced liver disease and/or coagulopathy are at increased risk for GI bleeding.

Strategies to Minimize the GI Risks in NSAID-treated patients:

- Use the lowest effective dosage for the shortest possible duration.
- Avoid administration of more than one NSAID at a time.
- Avoid use in patients at higher risk unless benefits are expected to outweigh the increased risk of bleeding.

For such patients, as well as those with active GI bleeding, consider alternate therapies other than NSAIDs.

- Remain alert for signs and symptoms of GI ulceration and bleeding during NSAID therapy.
- If a serious GI adverse event is suspected, promptly initiate evaluation and treatment, and discontinue Diclofenac Sodium Topical Gel until a serious GI adverse event is ruled out.
- In the setting of concomitant use of low-dose aspirin for cardiac prophylaxis, monitor patients more closely for evidence of GI bleeding [see *Drug Interactions* (7)].

5.3 Hepatotoxicity

In clinical trials, of oral diclofenac-containing products, meaningful elevations (i.e., more than 3 times the ULN) of AST (SGOT) were observed in about 2% of approximately 5,700 patients at some time during diclofenac treatment (ALT was not measured in all studies).

In a large, open-label, controlled trial of 3,700 patients treated with oral diclofenac sodium for 2-6 months, patients were monitored first at 8 weeks and 1,200 patients were monitored again at 24 weeks. Meaningful elevations of ALT and/or AST occurred in about 4% of 3,700 patients and included marked elevations (greater than 8 times the ULN) in about 1% of the 3,700 patients. In that open-label study, a higher incidence of borderline (less than 3 times the ULN), moderate (3-8 times the ULN), and marked (greater than 8 times the ULN) elevations of ALT or AST was observed in patients receiving diclofenac when compared to other NSAIDs. Elevations in transaminases were seen more frequently in patients with osteoarthritis than in those with rheumatoid arthritis.

Almost all meaningful elevations in transaminases were detected before patients became symptomatic. Abnormal tests occurred during the first 2 months of therapy with diclofenac in 42 of the 51 patients in all trials who developed marked transaminase elevations.

In postmarketing reports, cases of drug-induced hepatotoxicity have been reported in the first month, and in some cases, the first 2 months of therapy, but can occur at any time during treatment with diclofenac. Postmarketing surveillance has reported cases of severe hepatic reactions, including liver necrosis, jaundice, fulminant hepatitis with and without jaundice, and liver failure. Some of these reported cases resulted in fatalities or liver transplantation.

In a European retrospective population-based, case-controlled study, 10 cases of diclofenac associated drug-induced liver injury with current use compared with non-use of diclofenac were associated with a statistically significant 4-fold adjusted odds ratio of liver injury. In this particular study, based on an overall number of 10 cases of liver injury associated with diclofenac, the adjusted odds ratio increased further with female gender, doses of 150 mg or more, and duration of use for more than 90 days.

Physicians should measure transaminases at baseline and periodically in patients receiving long-term therapy with diclofenac, because severe hepatotoxicity may develop without a prodrome of distinguishing symptoms. The optimum times for making the first and subsequent transaminase measurements are not known. Based on clinical trial data and postmarketing experiences, transaminases should be monitored within 4 to 8 weeks after initiating treatment with diclofenac. However, severe hepatic reactions can occur at any time during treatment with diclofenac.

If abnormal liver tests persist or worsen, if clinical signs and/or symptoms consistent with liver disease develop, or if systemic manifestations occur (e.g., eosinophilia, rash, abdominal pain, diarrhea, dark urine, etc.), Diclofenac Sodium Topical Gel should be discontinued immediately.

Inform patients of the warning signs and symptoms of hepatotoxicity (e.g., nausea, fatigue, lethargy, diarrhea, pruritus, jaundice, right upper quadrant tenderness, and "flu-like" symptoms). If clinical signs and symptoms consistent with liver disease develop, or if systemic manifestations occur (e.g., eosinophilia, rash, etc.), discontinue Diclofenac Sodium Topical Gel immediately, and perform a clinical evaluation of the patient.

To minimize the potential risk for an adverse liver related event in patients treated with Diclofenac Sodium Topical Gel, use the lowest effective dose for the shortest duration possible. Exercise caution when prescribing Diclofenac Sodium Topical Gel with concomitant drugs that are known to be potentially hepatotoxic (e.g., acetaminophen, antibiotics, anti-epileptics).

5.4 Hypertension

NSAIDs, including Diclofenac Sodium Topical Gel, can lead to new onset of hypertension or worsening of preexisting hypertension, either of which may contribute to the increased incidence of CV events. Patients taking angiotensin converting enzyme (ACE) inhibitors, thiazide diuretics, or loop diuretics may have impaired response to these therapies when taking NSAIDs [see *Drug Interactions (7)*].

Monitor blood pressure (BP) during the initiation of NSAID treatment and throughout the course of therapy.

5.5 Heart Failure and Edema

The Coxib and traditional NSAID Trialists' Collaboration meta-analysis of randomized controlled trials demonstrated an approximately two-fold increase in hospitalizations for heart failure in COX-2 selective-treated patients and nonselective NSAID-treated patients compared to placebo-treated patients. In a Danish National Registry study of patients with heart failure, NSAID use increased the risk of MI, hospitalization for heart failure, and death.

Additionally, fluid retention and edema have been observed in some patients treated with NSAIDs. Use of diclofenac may blunt the CV effects of several therapeutic agents used to treat these medical conditions (e.g., diuretics, ACE inhibitors, or angiotensin receptor blockers [ARBs]) [see *Drug Interactions (7)*].

Avoid the use of Diclofenac Sodium Topical Gel in patients with severe heart failure unless the benefits are expected to outweigh the risk of worsening heart failure. If Diclofenac Sodium Topical Gel is used in patients with severe heart failure, monitor patients for signs of worsening heart failure.

5.6 Renal Toxicity and Hyperkalemia

Renal Toxicity

Long-term administration of NSAIDs has resulted in renal papillary necrosis and other renal injury.

Renal toxicity has also been seen in patients in whom renal prostaglandins have a compensatory role in the maintenance of renal perfusion. In these patients, administration of an NSAID may cause a dose-dependent reduction in prostaglandin formation and, secondarily, in renal blood flow, which may precipitate overt renal decompensation. Patients at greatest risk of this reaction are those with impaired renal function, dehydration, hypovolemia, heart failure, liver dysfunction, those taking diuretics and ACE-inhibitors or ARBs, and the elderly. Discontinuation of NSAID therapy is usually followed by recovery to the pretreatment state.

No information is available from controlled clinical studies regarding the use of Diclofenac Sodium Topical Gel in patients with advanced renal disease. The renal effects of

Diclofenac Sodium Topical Gel may hasten the progression of renal dysfunction in patients with preexisting renal disease.

Correct volume status in dehydrated or hypovolemic patients prior to initiating Diclofenac Sodium Topical Gel. Monitor renal function in patients with renal or hepatic impairment, heart failure, dehydration, or hypovolemia during use of Diclofenac Sodium Topical Gel [see *Drug Interactions (7)*]. Avoid the use of Diclofenac Sodium Topical Gel in patients with advanced renal disease unless the benefits are expected to outweigh the risk of worsening renal function. If Diclofenac Sodium Topical Gel is used in patients with advanced renal disease, monitor patients for signs of worsening renal function.

Hyperkalemia

Increases in serum potassium concentration, including hyperkalemia, have been reported with use of NSAIDs, even in some patients without renal impairment. In patients with normal renal function, these effects have been attributed to a hyporeninemic-hypoaldosteronism state.

5.7 Anaphylactic Reactions

Diclofenac has been associated with anaphylactic reactions in patients with and without known hypersensitivity to diclofenac and in patients with aspirin-sensitive asthma [see *Contraindications (4) and Warnings and Precautions (5.8)*].

Seek emergency help if an anaphylactic reaction occurs.

5.8 Exacerbation of Asthma Related to Aspirin Sensitivity

A subpopulation of patients with asthma may have aspirin-sensitive asthma which may include chronic rhinosinusitis complicated by nasal polyps; severe, potentially fatal bronchospasm; and/or intolerance to aspirin and other NSAIDs. Because cross-reactivity between aspirin and other NSAIDs has been reported in such aspirin-sensitive patients, Diclofenac Sodium Topical Gel is contraindicated in patients with this form of aspirin sensitivity [see *Contraindications (4)*]. When Diclofenac Sodium Topical Gel is used in patients with preexisting asthma (without known aspirin sensitivity), monitor patients for changes in the signs and symptoms of asthma.

5.9 Serious Skin Reactions

NSAIDs, including diclofenac, can cause serious skin adverse reactions such as exfoliative dermatitis, Stevens-Johnson Syndrome (SJS), and toxic epidermal necrolysis (TEN), which can be fatal. These serious events may occur without warning. Inform patients about the signs and symptoms of serious skin reactions, and to discontinue the use of Diclofenac Sodium Topical Gel at the first appearance of skin rash or any other sign of hypersensitivity. Diclofenac Sodium Topical Gel is contraindicated in patients with previous serious skin reactions to NSAIDs [see *Contraindications (4)*].

5.10 Premature Closure of Fetal Ductus Arteriosus

Diclofenac may cause premature closure of the fetal ductus arteriosus. Avoid use of NSAIDs, including Diclofenac Sodium Topical Gel, in pregnant women starting at 30 weeks of gestation (third trimester) [see *Use in Specific Populations (8.1)*].

5.11 Hematologic Toxicity

Anemia has occurred in NSAID-treated patients. This may be due to occult or gross blood loss, fluid retention, or an incompletely described effect on erythropoiesis. If a patient treated with Diclofenac Sodium Topical Gel has any signs or symptoms of anemia, monitor hemoglobin or hematocrit.

NSAIDs, including Diclofenac Sodium Topical Gel, may increase the risk of bleeding events. Co-morbid conditions such as coagulation disorders, concomitant use of warfarin, other anticoagulants, antiplatelet agents (e.g., aspirin), serotonin reuptake inhibitors (SSRIs) and serotonin norepinephrine reuptake inhibitors (SNRIs) may increase this risk. Monitor these patients for signs of bleeding [see *Drug Interactions (7)*].

5.12 Masking of Inflammation and Fever

The pharmacological activity of Diclofenac Sodium Topical Gel in reducing inflammation, and possibly fever, may diminish the utility of diagnostic signs in detecting infections.

5.13 Laboratory Monitoring

Because serious GI bleeding, hepatotoxicity, and renal injury can occur without warning symptoms or signs, consider monitoring patients on long-term NSAID treatment with a CBC and a chemistry profile periodically [see *Warnings and Precautions (5.2, 5.3, 5.6)*].

5.14 Sun Exposure

Patients should minimize or avoid exposure to natural or artificial sunlight on treated areas because studies in animals indicated topical diclofenac treatment resulted in an earlier onset of ultraviolet light induced skin tumors. The potential effects of Diclofenac Sodium Topical Gel on skin response to ultraviolet damage in humans are not known.

5.15 Eye Exposure

Contact of Diclofenac Sodium Topical Gel with eyes and mucosa, although not studied, should be avoided. Patients should be advised that if eye contact occurs, they should immediately wash out the eye with water or saline and consult a physician if irritation persists for more than an hour.

5.16 Oral Nonsteroidal Anti-inflammatory Drugs

Concomitant use of oral and topical NSAIDs may result in a higher rate of hemorrhage, more frequent abnormal creatinine, urea and hemoglobin. Do not use combination therapy with Diclofenac Sodium Topical Gel and an oral NSAID unless the benefit outweighs the risk.

6 ADVERSE REACTIONS

The following adverse reactions are discussed in greater detail in other sections of the labeling:

- Cardiovascular Thrombotic Events [see *Warnings and Precautions (5.1)*]
- GI Bleeding, Ulceration and Perforation [see *Warnings and Precautions (5.2)*]
- Hepatotoxicity [see *Warnings and Precautions (5.3)*]
- Hypertension [see *Warnings and Precautions (5.4)*]

- Heart Failure and Edema [see *Warnings and Precautions (5.5)*]
- Renal Toxicity and Hyperkalemia [see *Warnings and Precautions (5.6)*]
- Anaphylactic Reactions [see *Warnings and Precautions (5.7)*]
- Serious Skin Reactions [see *Warnings and Precautions (5.9)*]
- Hematologic Toxicity [see *Warnings and Precautions (5.11)*]

6.1 Clinical Trials Experience

Because clinical trials are conducted under widely varying conditions, adverse reaction rates observed in the clinical trials of a drug cannot be directly compared with rates in the clinical trials of another drug and may not reflect the rates observed in practice.

During clinical development, 913 patients were exposed to diclofenac sodium topical gel in randomized, double-blind, multicenter, vehicle-controlled, parallel-group studies in osteoarthritis of the superficial joints of the extremities. Of these, 513 patients received diclofenac sodium topical gel for osteoarthritis of the knee and 400 were treated for osteoarthritis of the hand. Additionally, 583 patients were exposed to diclofenac sodium topical gel in an uncontrolled, open-label, long-term safety trial in osteoarthritis of the knee. Of these, 355 patients were treated for osteoarthritis of 1 knee and 228 were treated for osteoarthritis of both knees. Duration of exposure ranged from 8 to 12 weeks for the placebo-controlled studies, and up to 12 months for the open-label safety trial.

Short-Term Placebo-Controlled Trials:

Adverse reactions observed in at least 1% of patients treated with diclofenac sodium topical gel:

Non-serious adverse reactions that were reported during the short-term placebo-controlled studies comparing diclofenac sodium topical gel and placebo (vehicle gel) over study periods of 8 to 12 weeks (16 g per day), were application site reactions. These were the only adverse reactions that occurred in >1% of treated patients with a greater frequency in the diclofenac sodium topical gel group (7%) than the placebo group (2%).

Table 1 lists the types of application site reactions reported. Application site dermatitis was the most frequent type of application site reaction and was reported by 4% of patients treated with diclofenac sodium topical gel, compared to 1% of placebo patients.

Table 1. Non-serious Application Site Adverse Reactions ($\geq 1\%$ Diclofenac Sodium Topical Gel Patients) - Short-term Controlled Trials

Adverse Reaction [†]	Diclofenac Sodium Topical Gel N=913	Placebo (vehicle) N=876
	N (%)	N (%)
<i>Any application site reaction</i>	62 (7)	19 (2)
Application site dermatitis	32 (4)	6 (<1)
Application site pruritus	7 (<1)	1 (<1)
Application site erythema	6 (<1)	3 (<1)
Application site paresthesia	5 (<1)	3 (<1)
Application site dryness	4 (<1)	3 (<1)
Application site vesicles	3 (<1)	0

Application site irritation	2 (<1)	0
Application site papules	1 (<1)	0

†Preferred Term according to MedDRA 9.1.

In the placebo-controlled trials, the discontinuation rate due to adverse reactions was 5% for patients treated with diclofenac sodium topical gel, and 3% for patients in the placebo group. Application site reactions, including application site dermatitis, were the most frequent reason for treatment discontinuation.

Long-Term Open-Label Safety Trial:

In the open-label, long-term safety study, distribution of adverse reactions was similar to that in the placebo-controlled studies. In this study, where patients were treated for up to 1 year with diclofenac sodium topical gel up to 32 g per day, application site dermatitis was observed in 11% of patients. Adverse reactions that led to the discontinuation of the study drug were experienced in 12% of patients. The most common adverse reaction that led to discontinuation of the study was application site dermatitis, which was experienced by 6% of patients.

7 DRUG INTERACTIONS

See Table 2 for clinically significant drug interactions with diclofenac.

Table 2: Clinically Significant Drug Interactions with Diclofenac

Drugs That Interfere with Hemostasis	
<i>Clinical Impact:</i>	<ul style="list-style-type: none"> • Diclofenac and anticoagulants such as warfarin have a synergistic effect on bleeding. The concomitant use of diclofenac and anticoagulants have an increased risk of serious bleeding compared to the use of either drug alone. • Serotonin release by platelets plays an important role in hemostasis. Case-control and cohort epidemiological studies showed that concomitant use of drugs that interfere with serotonin reuptake and an NSAID may potentiate the risk of bleeding more than an NSAID alone. <p>Serotonin release by platelets plays an important role in hemostasis. Case-control and cohort epidemiological studies showed that concomitant use of drugs that interfere with serotonin reuptake and an NSAID may potentiate the risk of bleeding more than an NSAID alone.</p>
<i>Intervention:</i>	Monitor patients with concomitant use of Diclofenac Sodium Topical Gel with anticoagulants (e.g., warfarin), antiplatelet agents (e.g., aspirin), selective serotonin reuptake inhibitors (SSRIs), and serotonin norepinephrine reuptake inhibitors (SNRIs) for signs of bleeding [see <i>Warnings and Precautions (5.11)</i>].
Aspirin	

<i>Clinical Impact:</i>	Controlled clinical studies showed that the concomitant use of NSAIDs and analgesic doses of aspirin does not produce any greater therapeutic effect than the use of NSAIDs alone. In a clinical study, the concomitant use of an NSAID and aspirin was associated with a significantly increased incidence of GI adverse reactions as compared to use of the NSAID alone [see <i>Warnings and Precautions (5.2)</i>].
<i>Intervention:</i>	Concomitant use of Diclofenac Sodium Topical Gel and analgesic doses of aspirin is not generally recommended because of the increased risk of bleeding [see <i>Warnings and Precautions (5.11)</i>]. Diclofenac Sodium Topical Gel is not a substitute for low dose aspirin for cardiovascular protection.

ACE Inhibitors, Angiotensin Receptor Blockers, and Beta-Blockers

<i>Clinical Impact:</i>	<ul style="list-style-type: none"> • NSAIDs may diminish the antihypertensive effect of angiotensin converting enzyme (ACE) inhibitors, angiotensin receptor blockers (ARBs), or beta-blockers (including propranolol) • In patients who are elderly, volume-depleted (including those on diuretic therapy), or have renal impairment, co-administration of an NSAID with ACE inhibitors or ARBs may result in deterioration of renal function, including possible acute renal failure. These effects are usually reversible. <p>In patients who are elderly, volume-depleted (including those on diuretic therapy), or have renal impairment, co-administration of an NSAID with ACE inhibitors or ARBs may result in deterioration of renal function, including possible acute renal failure. These effects are usually reversible.</p>
<i>Intervention:</i>	<ul style="list-style-type: none"> • During concomitant use of Diclofenac Sodium Topical Gel and ACE-inhibitors, ARBs, or beta-blockers, monitor blood pressure to ensure that the desired blood pressure is obtained. • During concomitant use of Diclofenac Sodium Topical Gel and ACE-inhibitors or ARBs in patients who are elderly, volume-depleted, or have impaired renal function, monitor for signs of worsening renal function [see <i>Warnings and Precautions (5.6)</i>]. • When these drugs are administered concomitantly, patients should be adequately hydrated. Assess renal function at the beginning of the concomitant treatment and periodically thereafter. <p>During concomitant use of Diclofenac Sodium Topical Gel and ACE-inhibitors or ARBs in patients who are elderly, volume-depleted, or have impaired renal function, monitor for signs of worsening renal function [see <i>Warnings and Precautions (5.6)</i>]. When these drugs are administered concomitantly, patients should be adequately hydrated. Assess renal function at the beginning of the concomitant treatment and periodically thereafter.</p>

Diuretics

<i>Clinical Impact:</i>	Clinical studies, as well as post-marketing observations, showed that
-------------------------	---

	NSAIDs reduced the natriuretic effect of loop diuretics (e.g., furosemide) and thiazide diuretics in some patients. This effect has been attributed to the NSAID inhibition of renal prostaglandin synthesis.
<i>Intervention:</i>	During concomitant use of Diclofenac Sodium Topical Gel with diuretics, observe patients for signs of worsening renal function, in addition to assuring diuretic efficacy including antihypertensive effects [see <i>Warnings and Precautions (5.6)</i>].
Digoxin	
<i>Clinical Impact:</i>	The concomitant use of diclofenac with digoxin has been reported to increase the serum concentration and prolong the half-life of digoxin.
<i>Intervention:</i>	During concomitant use of Diclofenac Sodium Topical Gel and digoxin, monitor serum digoxin levels.
Lithium	
<i>Clinical Impact:</i>	NSAIDs have produced elevations in plasma lithium levels and reductions in renal lithium clearance. The mean minimum lithium concentration increased 15%, and the renal clearance decreased by approximately 20%. This effect has been attributed to NSAID inhibition of renal prostaglandin synthesis.
<i>Intervention:</i>	During concomitant use of Diclofenac Sodium Topical Gel and lithium, monitor patients for signs of lithium toxicity.
Methotrexate	
<i>Clinical Impact:</i>	Concomitant use of NSAIDs and methotrexate may increase the risk for methotrexate toxicity (e.g., neutropenia, thrombocytopenia, renal dysfunction).
<i>Intervention:</i>	During concomitant use of Diclofenac Sodium Topical Gel and methotrexate, monitor patients for methotrexate toxicity.
Cyclosporine	
<i>Clinical Impact:</i>	Concomitant use of Diclofenac Sodium Topical Gel and cyclosporine may increase cyclosporine's nephrotoxicity.
<i>Intervention:</i>	During concomitant use of Diclofenac Sodium Topical Gel and cyclosporine, monitor patients for signs of worsening renal function.
NSAIDs and Salicylates	
<i>Clinical Impact:</i>	Concomitant use of diclofenac with other NSAIDs or salicylates (e.g., diflunisal, salsalate) increases the risk of GI toxicity, with little or no increase in efficacy [see <i>Warnings and Precautions (5.2)</i>].
<i>Intervention:</i>	The concomitant use of diclofenac with other NSAIDs or salicylates is not recommended.
Pemetrexed	
<i>Clinical Impact:</i>	Concomitant use of Diclofenac Sodium Topical Gel and pemetrexed may increase the risk of pemetrexed-associated myelosuppression, renal, and GI toxicity (see the pemetrexed prescribing information).
<i>Intervention:</i>	During concomitant use of Diclofenac Sodium Topical Gel and pemetrexed, in patients with renal impairment whose creatinine clearance ranges from 45 to 79 mL/min, monitor for myelosuppression, renal and GI toxicity. NSAIDs with short elimination half-lives (e.g., diclofenac,

indomethacin) should be avoided for a period of two days before, the day of, and two days following administration of pemetrexed. In the absence of data regarding potential interaction between pemetrexed and NSAIDs with longer half-lives (e.g., meloxicam, nabumetone), patients taking these NSAIDs should interrupt dosing for at least five days before, the day of, and two days following pemetrexed administration.

8 USE IN SPECIFIC POPULATIONS

8.1 Pregnancy

Pregnancy Category C prior to 30 weeks gestation; Category D starting 30 weeks gestation

Risk Summary

Use of NSAIDs, including Diclofenac Sodium Topical Gel, during the third trimester of pregnancy increases the risk of premature closure of the fetal ductus arteriosus. Avoid use of NSAIDs, including Diclofenac Sodium Topical Gel, in pregnant women starting at 30 weeks of gestation (third trimester).

There are no adequate and well-controlled studies of diclofenac sodium topical gel in pregnant women. Human and animal studies indicate that diclofenac crosses the placenta. Data from observational studies regarding potential embryofetal risks of NSAID use in women in the first or second trimesters of pregnancy are inconclusive. In the general U.S. population, all clinically recognized pregnancies, regardless of drug exposure, have a background rate of 2-4% for major malformations, and 15-20% for pregnancy loss. In animal reproduction studies, no evidence of teratogenicity was observed in mice, rats, or rabbits given diclofenac during the period of organogenesis at doses up to approximately 5, 5, and 10 times, respectively, the maximum recommended topical dose of diclofenac sodium topical gel, despite the presence of maternal and fetal toxicity at these doses [see *Data*]. Based on animal data, prostaglandins have been shown to have an important role in endometrial vascular permeability, blastocyst implantation, and decidualization. In animal studies, administration of prostaglandin synthesis inhibitors such as diclofenac, resulted in increased pre- and post-implantation loss.

Clinical Considerations

Labor or Delivery

There are no studies on the effects of diclofenac sodium topical gel during labor or delivery. In animal studies, NSAIDs, including diclofenac, inhibit prostaglandin synthesis, cause delayed parturition, and increase the incidence of stillbirth.

Data

Animal data

Reproductive and developmental studies in animals demonstrated that diclofenac sodium administration during organogenesis did not produce teratogenicity despite the induction of maternal toxicity and fetal toxicity in mice at oral doses up to 20 mg/kg/day

(approximately 5 times the maximum recommended human dose (MRHD) of diclofenac sodium topical gel based on bioavailability and body surface area (BSA) comparison), and in rats and rabbits at oral doses up to 10 mg/kg/day (approximately 5 and 10 times the MRHD based on bioavailability and BSA comparison).

In a study in which pregnant rats were orally administered 2 or 4 mg/kg diclofenac (approximately 1 and 2 times the MRHD based on bioavailability and BSA comparison) from Gestation Day 15 through Lactation Day 21, significant maternal toxicity (peritonitis, mortality) was noted. These maternally toxic doses were associated with dystocia, prolonged gestation, reduced fetal weights and growth, and reduced fetal survival.

8.2 Lactation

Risk Summary

Based on available data, diclofenac may be present in human milk. The developmental and health benefits of breastfeeding should be considered along with the mother's clinical need for CATAFLAM and any potential adverse effects on the breastfed infant from the CATAFLAM or from the underlying maternal condition.

Data

One woman treated orally with a diclofenac salt, 150 mg/day, had a milk diclofenac level of 100 mcg/L, equivalent to an infant dose of about 0.03 mg/kg/day. Diclofenac was not detectable in breast milk in 12 women using diclofenac (after either 100 mg/day orally for 7 days or a single 50 mg intramuscular dose administered in the immediate postpartum period).

8.3 Females and Males of Reproductive Potential

Infertility

Females

Based on the mechanism of action, the use of prostaglandin-mediated NSAIDs, including Diclofenac Sodium Topical Gel, may delay or prevent rupture of ovarian follicles, which has been associated with reversible infertility in some women. Published animal studies have shown that administration of prostaglandin synthesis inhibitors has the potential to disrupt prostaglandin-mediated follicular rupture required for ovulation. Small studies in women treated with NSAIDs have also shown a reversible delay in ovulation. Consider withdrawal of NSAIDs, including Diclofenac Sodium Topical Gel, in women who have difficulties conceiving or who are undergoing investigation of infertility.

8.4 Pediatric Use

Safety and effectiveness in pediatric patients have not been established.

8.5 Geriatric Use

Elderly patients, compared to younger patients, are at greater risk for NSAID-associated serious cardiovascular, gastrointestinal, and/or renal adverse reactions. If the anticipated benefit for the elderly patient outweighs these potential risks, start dosing at the low end of the dosing range, and monitor patients for adverse effects [*see Warnings and Precautions (5.1, 5.2, 5.3, 5.6, 5.13)*].

Of the total number of subjects treated with diclofenac sodium topical gel in clinical studies, 498 were 65 years of age and over. No overall differences in effectiveness or safety were observed between these subjects and younger subjects, but greater sensitivity to the effect of NSAIDs in some older individuals cannot be ruled out.

Diclofenac, as with any NSAID, is known to be substantially excreted by the kidney, and the risk of toxic reactions to Diclofenac Sodium Topical Gel may be greater in patients with impaired renal function. Because elderly patients are more likely to have decreased renal function, care should be taken when using Diclofenac Sodium Topical Gel in the elderly, and it may be useful to monitor renal function.

10 OVERDOSAGE

Symptoms following acute NSAID overdoses have been typically limited to lethargy, drowsiness, nausea, vomiting, and epigastric pain, which have been generally reversible with supportive care. Gastrointestinal bleeding has occurred. Hypertension, acute renal failure, respiratory depression, and coma have occurred, but were rare [see *Warnings and Precautions* (5.1, 5.2, 5.4, 5.6)].

Manage patients with symptomatic and supportive care following an NSAID overdose. There are no specific antidotes. Forced diuresis, alkalinization of urine, hemodialysis, or hemoperfusion may not be useful due to high protein binding.

For additional information about overdose treatment, contact a poison control center (1-800-222-1222).

11 DESCRIPTION

Diclofenac Sodium Topical Gel, 1% is a nonsteroidal anti-inflammatory drug (NSAID) for topical use only. The chemical name is 2-[(2,6-dichlorophenyl) amino]benzene-acetic acid, monosodium salt. The molecular weight is 318.14. Its molecular formula is $C_{14}H_{10}Cl_2NNaO_2$, and it has the following chemical structure:

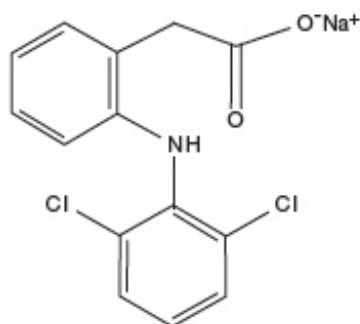

It contains the active ingredient, diclofenac sodium, in an opaque, white gel base. Diclofenac sodium is a white to slightly yellow crystalline powder. Diclofenac sodium is a benzeneacetic acid derivative.

The inactive ingredients in Diclofenac Sodium Topical Gel include: carbomer

homopolymer Type C, cocoyl caprylocaprate, fragrance, isopropyl alcohol, mineral oil, polyoxyl 20 cetostearyl ether, propylene glycol, purified water, and strong ammonia solution.

12 CLINICAL PHARMACOLOGY

12.1 Mechanism of Action

Diclofenac has analgesic, anti-inflammatory, and antipyretic properties.

The mechanism of action of Diclofenac Sodium Topical Gel, like that of other NSAIDs, is not completely understood but involves inhibition of cyclooxygenase (COX-1 and COX-2).

Diclofenac is a potent inhibitor of prostaglandin synthesis in vitro. Diclofenac concentrations reached during therapy have produced in vivo effects. Prostaglandins sensitize afferent nerves and potentiate the action of bradykinin in inducing pain in animal models. Prostaglandins are mediators of inflammation. Because diclofenac is an inhibitor of prostaglandin synthesis, its mode of action may be due to a decrease of prostaglandins in peripheral tissues.

12.3 Pharmacokinetics

The pharmacokinetics of diclofenac sodium topical gel were assessed in healthy volunteers following repeated applications during 7 days of diclofenac sodium topical gel to 1 knee (4 x 4 g per day) or to 2 knees and 2 hands (4 x 12 g per day) versus the recommended oral dose of diclofenac sodium for the treatment of osteoarthritis (3 x 50 mg per day). A summary of the pharmacokinetic parameters is presented in Table 3.

Table 3. Pharmacokinetic Parameters and Comparison of Diclofenac Sodium Topical Gel to Oral Diclofenac Sodium Tablets After Repeated Administration

Treatment	C_{max} (ng/mL) Mean ± SD % of Oral (CI)	T_{max} (hr) Median Range	AUC₀₋₂₄ (ng•h/mL) Mean ± SD % of Oral (CI)
Diclofenac sodium topical gel 4 x 4 g per day (=160 mg diclofenac sodium per day)	15 ± 7.3 0.6% (0.5-0.7)	14 (0-24)	233 ± 128 5.8% (5-6.7)
Diclofenac sodium topical gel 4 x 12 g per day (=480 mg diclofenac sodium per day)	53.8 ± 32 2.2% (1.9-2.6)	10 (0-24)	807 ± 478 19.7% (17-22.8)
Diclofenac sodium tablets, orally 3 x 50 mg per day (=150 mg diclofenac sodium per day)	2270 ± 778 100%	6.5 (1-14)	3890 ± 1710 100%

C_{max} = maximum plasma concentration, t_{max} = time of C_{max}. AUC₀₋₂₄ = area under the concentration time curve.

SD=standard deviation. CI=confidence interval.

Systemic exposure (area under the concentration-time curve) and maximum plasma concentrations of diclofenac are significantly lower with diclofenac sodium topical gel than with comparable oral treatment of diclofenac sodium.

Systemic exposure with recommended use of diclofenac sodium topical gel (4 x 4 g per day applied to 1 knee) is on average 17 times lower than with oral treatment. (Basis: treatment with diclofenac sodium topical gel of 1 knee, 4 times a day versus 50 mg, 3 times a day of oral diclofenac tablets.) The amount of diclofenac sodium that is systemically absorbed from diclofenac sodium topical gel is on average 6% of the systemic exposure from an oral form of diclofenac sodium.

The average peak plasma concentration with recommended use of diclofenac sodium topical gel (4 x 4 g per day applied to 1 knee) is 158 times lower than with the oral treatment.

The pharmacokinetics of diclofenac sodium topical gel has been tested under conditions of moderate heat (application of a heat patch for 15 minutes prior to gel application) and of moderate exercise (first gel application followed by a 20-minute treadmill exercise). No clinically relevant differences of systemic absorption and of tolerability were found between applications of diclofenac sodium topical gel (4 x 4 g per day on 1 knee) with and under the conditions tested. However, the pharmacokinetics of diclofenac sodium topical gel were not tested under the condition of heat application following gel application. Therefore, concurrent use of diclofenac sodium topical gel and heat is not recommended.

Drug Interaction Studies

Aspirin: When NSAIDs were administered with aspirin, the protein binding of NSAIDs were reduced, although the clearance of free NSAID was not altered. The clinical significance of this interaction is not known. See Table 2 for clinically significant drug interactions of NSAIDs with aspirin [see *Drug Interactions (7)*].

13 NONCLINICAL TOXICOLOGY

13.1 Carcinogenesis, Mutagenesis, Impairment of Fertility

Carcinogenesis

Carcinogenicity studies in mice and rats administered diclofenac sodium as a dietary constituent for 2 years at doses up to 2 mg/kg/day (approximately 0.5 and 1 times, respectively, the maximum recommended human topical dose of diclofenac sodium topical gel based on bioavailability and body surface area (BSA) comparison) resulted in no significant increases in tumor incidence.

In a dermal carcinogenicity study conducted in albino mice, daily topical applications of a diclofenac sodium gel product for two years at concentrations up to 0.035% diclofenac sodium (a 29-fold lower diclofenac sodium concentration than present in diclofenac sodium topical gel) did not increase neoplasm incidence.

In a photocarcinogenicity study conducted in hairless mice, topical application of a diclofenac sodium gel product at doses up to 0.035% diclofenac sodium (a 29-fold lower diclofenac sodium concentration than present in diclofenac sodium topical gel) resulted in an earlier median time of onset of tumors.

Mutagenesis

Diclofenac was not mutagenic or clastogenic in a battery of genotoxicity tests that included the bacterial reverse mutation assay, *in vitro* mouse lymphoma point mutation assay, chromosomal aberration studies in Chinese hamster ovarian cells *in vitro*, and *in vivo* rat chromosomal aberration assay of bone marrow cells.

Impairment of Fertility

Diclofenac did not affect male or female fertility in rats at doses up to 4 mg/kg/day (approximately 2 times than the maximum human topical dose of diclofenac sodium topical gel based on bioavailability and BSA comparison).

14 CLINICAL STUDIES

14.1 Pivotal Studies in Osteoarthritis of the Superficial Joints of the Extremities

Study 1 evaluated the efficacy of diclofenac sodium topical gel for the treatment of osteoarthritis of the knee in a 12-week, randomized, double-blind, multicenter, placebo-controlled, parallel-group trial. Diclofenac sodium topical gel was administered at a dose of 4 g, 4 times daily, on 1 knee (16 g per day). Pain as assessed by the patients at Week 12 using the WOMAC (Western Ontario and McMaster Universities Osteoarthritis Index) Pain Subindex was lower in the diclofenac sodium topical gel group than the placebo group.

Study 2 evaluated the efficacy of diclofenac sodium topical gel for the treatment of osteoarthritis in subjects with osteoarthritis of the hand in an 8-week, randomized, double-blind, multicenter, placebo-controlled, parallel-group study. Diclofenac sodium topical gel was administered at a dose of 2 g per hand, 4 times daily, on both hands (16 g per day). Pain in the target hand as assessed by the patients at Weeks 4 and 6 on a visual analog scale from 0 to 100 was lower in the diclofenac sodium topical gel group than the placebo group.

Table 4. Efficacy outcomes of Diclofenac Sodium Topical Gel in Studies 1 and 2

		Diclofenac Sodium Topical Gel	Placebo (Vehicle)	Adjusted Difference (Placebo - Diclofenac Sodium Topical Gel)
Study 1 (Knee) WOMAC Pain^{*#} at Week 12	Sample Size	127	119	
	Mean Outcome	28	37	$\Delta=7^{\dagger}$
	95% Confidence Interval			(1, 12)
Study 2 (Hand) Pain Intensity[#] at Week 4	Sample Size	198	187	
	Mean Outcome	43	50	$\Delta=7^{\ddagger}$
	95% Confidence Interval			(2, 12)

Study 2 (Hand) Pain Intensity# at Week 6	Sample Size	198	187	
	Mean Outcome	40	47	$\Delta=7^\ddagger$
	95% Confidence Interval			(1, 13)

* WOMAC = Western Ontario McMaster Osteoarthritis Index.

Scale from 0 (best) to 100 (worst).

† Difference is adjusted using an analysis of covariance (ANCOVA) model with main effects of treatment and center and baseline covariate.

‡ Difference is adjusted using an analysis of covariance (ANCOVA) model with main effects of treatment, center, indicator of pain in the CMC-1 joint, and baseline as a covariate, and the treatment-by-CMC-1 strata.

16 HOW SUPPLIED/STORAGE AND HANDLING

Diclofenac Sodium Topical Gel, 1% is an opaque white gel and is available in tubes containing 100 grams of the topical gel in each tube.

Each tube contains diclofenac sodium in a gel base (10 mg of diclofenac sodium per gram of gel or 1%).

100 grams tube..... NDC 45802-**160**-00

Storage

Store at room temperature 20°C to 25°C (68°F to 77°F) [See USP Controlled Room Temperature].

Keep from freezing. Store the dosing card with your Diclofenac Sodium Topical Gel.

17 PATIENT COUNSELING INFORMATION

Advise the patient to read the FDA-approved patient labeling (Medication Guide and Instructions for Use) that accompanies each prescription dispensed. Patients, families, or their caregivers should be informed of the following information before initiating therapy with Diclofenac Sodium Topical Gel and periodically during the course of ongoing therapy.

Cardiovascular Thrombotic Events

Advise patients to be alert for the symptoms of cardiovascular thrombotic events, including chest pain, shortness of breath, weakness, or slurring of speech, and to report any of these symptoms to their health care provider immediately [see *Warnings and Precautions (5.1)*].

Gastrointestinal Bleeding, Ulceration, and Perforation

Advise patients to report symptoms of ulcerations and bleeding, including epigastric pain, dyspepsia, melena, and hematemesis to their healthcare provider. In the setting of concomitant use of low-dose aspirin for cardiac prophylaxis, inform patients of the increased risk for and the signs and symptoms of GI bleeding [see *Warnings and*

Precautions (5.2)].

Hepatotoxicity

Inform patients of the warning signs and symptoms of hepatotoxicity (e.g., nausea, fatigue, lethargy, pruritus, diarrhea, jaundice, right upper quadrant tenderness, and “flu-like” symptoms). If these occur, instruct patients to stop Diclofenac Sodium Topical Gel and seek immediate medical therapy [*see Warnings and Precautions (5.3)*].

Heart Failure and Edema

Advise patients to be alert for the symptoms of congestive heart failure including shortness of breath, unexplained weight gain, or edema and to contact their healthcare provider if such symptoms occur [*see Warnings and Precautions (5.5)*].

Anaphylactic Reactions

Inform patients of the signs of an anaphylactic reaction (e.g., difficulty breathing, swelling of the face or throat).

Instruct patients to seek immediate emergency help if these occur [*see Contraindications (4) and Warnings and Precautions (5.7)*].

Serious Skin Reactions

Advise patients to stop Diclofenac Sodium Topical Gel immediately if they develop any type of rash and to contact their healthcare provider as soon as possible [*see Warnings and Precautions (5.9)*].

Female Fertility

Advise females of reproductive potential who desire pregnancy that NSAIDs, including Diclofenac Sodium Topical Gel, may be associated with a reversible delay in ovulation [*see Use in Specific Populations (8.3)*].

Fetal Toxicity

Inform pregnant women to avoid use of Diclofenac Sodium Topical Gel and other NSAIDs starting at 30 weeks gestation because of the risk of the premature closing of the fetal ductus arteriosus [*see Warnings and Precautions(5.10) and Use in Specific Populations (8.1)*].

Avoid Concomitant Use of NSAIDs

Inform patients that the concomitant use of Diclofenac Sodium Topical Gel with other NSAIDs or salicylates (e.g., diflunisal, salsalate) is not recommended due to the increased risk of gastrointestinal toxicity, and little or no increase in efficacy [*see Warnings and Precautions (5. 2) and Drug Interactions (7)*]. Alert patients that NSAIDs may be present in "over the counter" medications for treatment of colds, fever, or insomnia.

Use of NSAIDs and Low-Dose Aspirin

Inform patients not to use low-dose aspirin concomitantly with Diclofenac Sodium Topical Gel until they talk to their healthcare provider [*see Drug Interactions (7)*].

Eye Exposure

Instruct patients to avoid contact of Diclofenac Sodium Topical Gel with the eyes and

mucosa. Advise patients that if eye contact occurs, immediately wash out the eye with water or saline and consult a physician if irritation persists for more than an hour [see *Warnings and Precautions (5.15)*].

Special Application Instructions

Instruct patients how to use the dosing card to measure the proper dose of Diclofenac Sodium Topical Gel to apply.

If the patient loses their dosing card, instruct them that they can call 1-866-634-9120 to request a replacement dosing card or ask their pharmacist for a new dosing card.

Instruct patients how to correctly measure the 2.25 inches (2 g) dose or 4.5 inches (4 g) dose while waiting for a replacement dosing card [see *Dosage and Administration (2.2)*].

Instruct patients not to apply Diclofenac Sodium Topical Gel to open skin wounds, infections, inflammations, or exfoliative dermatitis, as it may affect absorption and tolerability of the drug.

Instruct patients to avoid concomitant use of Diclofenac Sodium Topical Gel with other topical products, including sunscreens, cosmetics, lotions, moisturizers, and insect repellents. Concomitant use may result in skin reactions or change the absorption of Diclofenac Sodium Topical Gel.

Instruct patients to minimize or avoid exposure of treated areas to natural or artificial sunlight [see *Warnings and Precautions (5.14)* and *Dosage and Administration (2.4)*].

Comments or Questions? Call toll-free 1-866-634-9120

Manufactured By Perrigo, Yeruham, Israel

Distributed By

Perrigo®

Allegan, MI 49010 • www.perrigo.com

Revised: April 2019

2G3C1 RC J3

Medication Guide for Nonsteroidal Anti-inflammatory Drugs (NSAIDs)

What is the most important information I should know about medicines called Nonsteroidal Anti-inflammatory Drugs (NSAIDs)?

NSAIDs can cause serious side effects, including:

- **Increased risk of a heart attack or stroke that can lead to death.** This risk may happen early in treatment and may increase:
 - o with increasing doses of NSAIDs
 - o with longer use of NSAIDs

Do not take NSAIDs right before or after a heart surgery called a “coronary artery bypass graft (CABG).”

Avoid taking NSAIDs after a recent heart attack, unless your healthcare provider tells you to.

You may have an increased risk of another heart attack if you take NSAIDs after a recent heart attack.

- **Increased risk of bleeding, ulcers, and tears (perforation) of the esophagus (tube leading from the mouth to the stomach), stomach and intestines:**
 - o anytime during use
 - o without warning symptoms
 - o that may cause death

The risk of getting an ulcer or bleeding increases with:

- o past history of stomach ulcers, or stomach or intestinal bleeding with use of NSAIDs
- o taking medicines called “corticosteroids”, “anticoagulants”, “SSRIs”, or “SNRIs”
- o increasing doses of NSAIDs
- o older age
- o longer use of NSAIDs
- o poor health
- o smoking
- o advanced liver disease
- o drinking alcohol
- o bleeding problems

NSAIDs should only be used:

- o exactly as prescribed
- o at the lowest dose possible for your treatment
- o for the shortest time needed

What are NSAIDs?

NSAIDs are used to treat pain and redness, swelling, and heat (inflammation) from medical conditions such as different types of arthritis, menstrual cramps, and other types of short-term pain.

Who should not take NSAIDs?

Do not take NSAIDs:

- if you have had an asthma attack, hives, or other allergic reaction with aspirin or any other NSAIDs.
- right before or after heart bypass surgery.

Before taking NSAIDs, tell your healthcare provider about all of your medical conditions, including if you:

- have liver or kidney problems
- have high blood pressure
- have asthma
- are pregnant or plan to become pregnant. Talk to your healthcare provider if you are considering taking NSAIDs during pregnancy.
You should not take or use NSAIDs after 29 weeks of pregnancy.
- are breastfeeding or plan to breastfeed.

Tell your healthcare provider about all of the medicines you take, including prescription or over-the-counter medicines, vitamins, or herbal supplements. NSAIDs and some other medicines can interact with each other and cause serious side effects. **Do not start taking new medicine without talking to your healthcare provider first.**

What are the possible side effects of NSAIDs?

NSAIDs can cause serious side effects, including:

See “What is the most important information I should know about medicines called Nonsteroidal Anti-inflammatory Drugs (NSAIDs)?”

- new or worse high blood pressure
- heart failure
- liver problems including liver failure
- kidney problems including kidney failure
- low red blood cells (anemia)
- life-threatening skin reactions
- life-threatening allergic reactions
- **Other side effects of NSAIDs include:** stomach pain, constipation, diarrhea, gas, heartburn, nausea, vomiting and dizziness.

Get emergency help right away if you get any of the following symptoms:

- shortness of breath or trouble breathing
- chest pain
- weakness in one part or side of your body
- slurred speech
- swelling of the face or throat

Stop taking your NSAID and call your healthcare provider right away if you get any of the following symptoms:

- nausea
- more tired or weaker than usual
- diarrhea
- itching
- your skin or eyes look yellow
- indigestion or stomach pain
- flu-like symptoms
- vomit blood
- there is blood in your bowel movement or it is black and sticky like tar
- unusual weight gain

- skin rash or blisters with fever
- swelling of the arms, legs, hands and feet

If you take too much of your NSAID, call your healthcare provider or get medical help right away.

These are not all the possible side effects of NSAIDs.

For more information, ask your healthcare provider or pharmacist about NSAIDs.

Call your doctor for medical advice about side effects.

You may report side effects to FDA at 1-800-FDA-1088.

Other information about NSAIDs

- Aspirin is an NSAID but it does not increase the chance of a heart attack. Aspirin can cause bleeding in the brain, stomach, and intestines. Aspirin can also cause ulcers in the stomach and intestines.
- Some NSAIDs are sold in lower doses without a prescription (over-the-counter). Talk to your healthcare provider before using over-the-counter NSAIDs for more than 10 days.

General information about the safe and effective use of NSAIDs

Medicines are sometimes prescribed for purposes other than those listed in a Medication Guide. Do not use NSAIDs for a condition for which it was not prescribed. Do not give NSAIDs to other people, even if they have the same symptoms that you have. It may harm them.

If you would like more information about NSAIDs, talk with your healthcare provider. You can ask your pharmacist or healthcare provider for information about NSAIDs that is written for health professionals.

Manufactured By Perrigo, Yeruham, Israel

Distributed By Perrigo, Allegan, MI 49010

For more information, go to www.perrigo.com or call 1-866-634-9120.

This Medication Guide has been approved by the U.S. Food and Drug Administration.

Revised April 2019

2G300 RC IC2

Instructions for Use

Diclofenac Sodium Topical Gel, 1%

Important: Use the dosing card that is inside the Diclofenac Sodium Topical Gel carton to correctly measure each dose. The dosing card is re-usable. Do not throw the dosing card away. Before you use Diclofenac Sodium Topical Gel for the first time, your healthcare provider or pharmacist should show you how to correctly measure your dose using the dosing card.

Read this **Instructions for Use** before you start using Diclofenac Sodium Topical Gel

and each time you get a refill. There may be new information. This information does not take the place of talking to your healthcare provider about your medical condition or your treatment.

Your healthcare provider has prescribed Diclofenac Sodium Topical Gel to help relieve arthritis pain in some of your joints. Diclofenac Sodium Topical Gel may be used to treat arthritis pain in the arms (hands, wrists, and elbows) and in the legs (feet, ankles, and knees). It is not known if Diclofenac Sodium Topical Gel is safe and effective if used on your spine, hips, or shoulders.

- Use Diclofenac Sodium Topical Gel exactly how your healthcare provider prescribes it for you. Do not apply Diclofenac Sodium Topical Gel anywhere other than where your healthcare provider tells you to.
- **Do not use more than a total of 32 grams of Diclofenac Sodium Topical Gel each day. If you add up the amount of Diclofenac Sodium Topical Gel as directed by your healthcare provider, it should not be more than 32 grams in one day.**

The dose for your hands, wrists, or elbows is 2 grams of Diclofenac Sodium Topical Gel each time you apply it.

- Apply Diclofenac Sodium Topical Gel 4 times a day (a total of 8 grams each day). Do not apply more than 8 grams each day to any one of your affected hands, wrists, or elbows.

The dose for your feet, ankles, or knees is 4 grams of Diclofenac Sodium Topical Gel each time you apply it.

- Apply Diclofenac Sodium Topical Gel 4 times a day (a total of 16 grams each day). Do not apply more than 16 grams each day to any one of your affected feet, ankles, or knees.

Some examples of Diclofenac Sodium Topical Gel application include:

- If you use 2 grams of Diclofenac Sodium Topical Gel on one hand, 4 times a day, your total dose for one day is 8 grams.
- If you use 4 grams of Diclofenac Sodium Topical Gel on one knee, 4 times a day, your total dose for one day is 16 grams.
- Your total dose for one day, treating one hand and one knee, is 8 grams plus 16 grams, which equals 24 grams of Diclofenac Sodium Topical Gel
- Before you use a new tube of Diclofenac Sodium Topical Gel for the first time, open the foil seal that covers the tube opening by using the spiked top of the cap. (see Figures A and B)

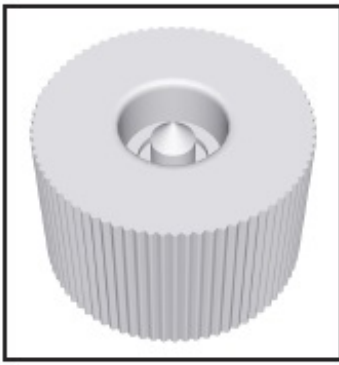
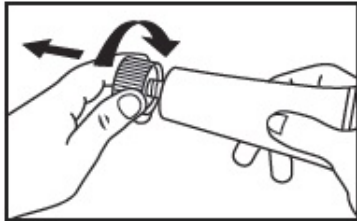
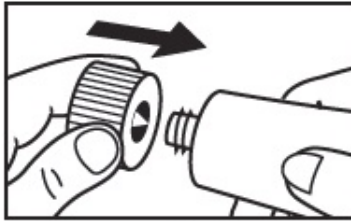

Figure A



1. Unscrew cap.



2. Puncture seal with pointed end of cap.
3. Do not open the foil seal with scissors or other sharp objects.

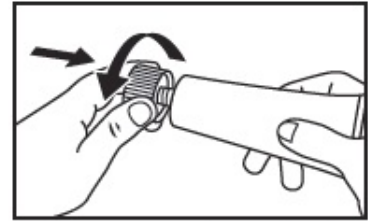

4. After use, put the cap back on the end of the tube and store in an upright position.

Figure B

- Remember to remove the dosing card from the carton to measure your dose (see Figure C).

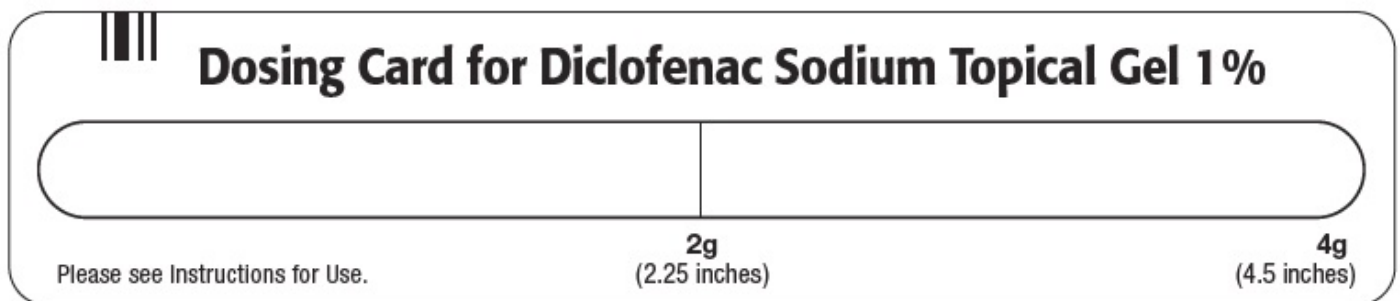

Figure C

- Apply Diclofenac Sodium Topical Gel to clean, dry skin that does not have any cuts, open wounds, infections, or rashes.
- Do not use heating pads or apply bandages to where you have applied Diclofenac Sodium Topical Gel.
- Avoid exposing skin where you apply Diclofenac Sodium Topical Gel to sunlight and artificial light, such as tanning booths.
- Do not use sunscreens, cosmetics, lotions, moisturizers, insect repellants, or other topical medicines on the same skin areas where you have applied Diclofenac Sodium Topical Gel.
- Do not get Diclofenac Sodium Topical Gel in your eyes, nose, or mouth. Diclofenac Sodium Topical Gel is only to be used on your skin (topical use). If you get

Diclofenac Sodium Topical Gel in your eyes, rinse your eyes right away with water or saline. Talk with your healthcare provider if eye irritation lasts for more than one hour.

What if I miss a dose?

- If you miss a dose of Diclofenac Sodium Topical Gel, continue with your next scheduled dose using the prescribed amount of Diclofenac Sodium Topical Gel. **Do not double the dose.**

Applying 2 grams (2 g) of Diclofenac Sodium Topical Gel to hands, wrists, or elbows:

Step 1. Remove the dosing card that is attached inside the Diclofenac Sodium Topical Gel carton. Use the dosing card to correctly measure each dose of Diclofenac Sodium Topical Gel. To measure the correct amount of Diclofenac Sodium Topical Gel, place the dosing card on a flat surface so that you can read the print. If the print is backwards, flip dosing card over (see Figure C). If you lose or misplace your dosing card, you can ask your pharmacist for a new one or call 1-866-634-9120. Ask your healthcare provider or pharmacist to show you how to correctly measure your dose of Diclofenac Sodium Topical Gel while you are waiting to receive your new dosing card.

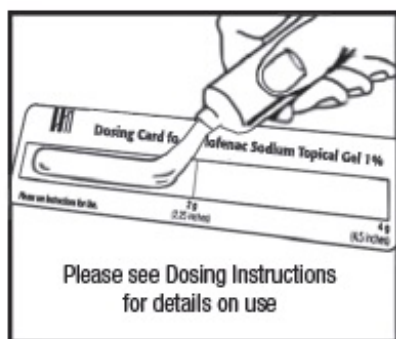

Figure D

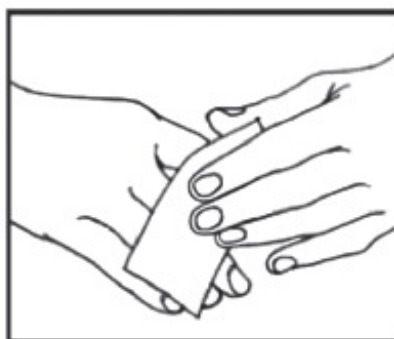

Figure E

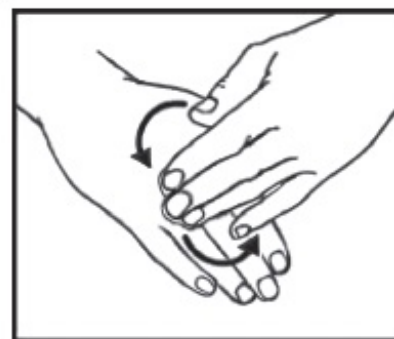

Figure F

Step 2. Squeeze Diclofenac Sodium Topical Gel onto the dosing card evenly, up to the 2 g line (a 2.25 inch length of gel). Make sure that the gel covers the 2 g area of the dosing card (see Figure D). Put the cap back on the tube of Diclofenac Sodium Topical Gel. Ask your healthcare provider or pharmacist if you are not sure how to correctly measure your dose of Diclofenac Sodium Topical Gel.

Step 3. Apply the gel to your hand, wrist, or elbow. You can use the dosing card to apply the gel (see Figure E). Then, use your hands to gently rub the gel into the skin (see Figure F). Do not share your dosing card with another person. Make sure to cover the entire affected hand, wrist, or elbow with the gel. Remember that the hand includes the palm of your hand, the top of your hand, and your fingers.

Step 4. After using the dosing card, hold end with fingertips, rinse and dry. **Store the dosing card until next use.** Do not shower or bathe for at least 1 hour after applying Diclofenac Sodium Topical Gel. Do not wash your treated hands for at least 1 hour after applying the Diclofenac Sodium Topical Gel.

Step 5. After applying Diclofenac Sodium Topical Gel, wait 10 minutes before covering the treated skin with gloves or clothing.

Applying 4 grams (4 g) of Diclofenac Sodium Topical Gel to feet, ankles, or knees:

Step 1. Refer to **Step 1** above.

Step 2. Squeeze Diclofenac Sodium Topical Gel onto the dosing card evenly up to the 4 g line (a 4.5 inch length of gel), making sure the gel covers the 4 g area of the dosing card (see Figure G). Put the cap back on the tube of Diclofenac Sodium Topical Gel. Ask your healthcare provider or pharmacist if you are not sure how to correctly measure your dose of Diclofenac Sodium Topical Gel.

Step 3. Apply Diclofenac Sodium Topical Gel to your foot, ankle, or knee. You can use the dosing card to apply the gel (see Figure H). Then, use your hands to gently rub the gel into the skin (see Figure I). Do not share your dosing card with another person. Make sure to cover your entire foot, ankle, or knee area with the gel. For example, cover the skin above, below, inside and outside the knee cap. Remember that the foot includes the sole of your foot, the top of your foot, and your toes.

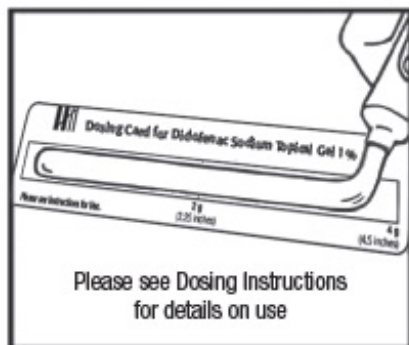

Figure G



Figure H



Figure I

Refer to Steps 4 and 5 above. Wash your hands after applying Diclofenac Sodium Topical Gel to your foot, ankle, or knee.

What are the ingredients in Diclofenac Sodium Topical Gel?

Active ingredient: diclofenac sodium

Inactive ingredients: carbomer homopolymer Type C, cocoyl caprylocaprate, fragrance, isopropyl alcohol, mineral oil, polyoxyl 20 cetostearyl ether, propylene glycol, purified water, and strong ammonia solution.

How should I store Diclofenac Sodium Topical Gel?

- Store at 20°C to 25°C (68°F to 77°F).
- **Do not** freeze Diclofenac Sodium Topical Gel.
- Store the dosing card with your Diclofenac Sodium Topical Gel.

Keep Diclofenac Sodium Topical Gel, the dosing card, and all medicines out of the reach of children.

This Medication Guide and Instructions for Use have been approved by the U.S. Food and Drug Administration.

Manufactured By Perrigo

Yeruham, Israel

Distributed By Perrigo

Allegan, MI 49010

www.perrigo.com

Revised: April 2019

2G300 RC IC2

PACKAGE/LABEL PRINCIPAL DISPLAY PANEL

Rx Only

NDC 45802-**160**-00

Diclofenac Sodium Topical Gel, 1%

For Topical Use Only

See Medication Guide and Patient Instructions Inside of Carton

NET WT 100 g

Use the Dosing Card Attached Inside Carton

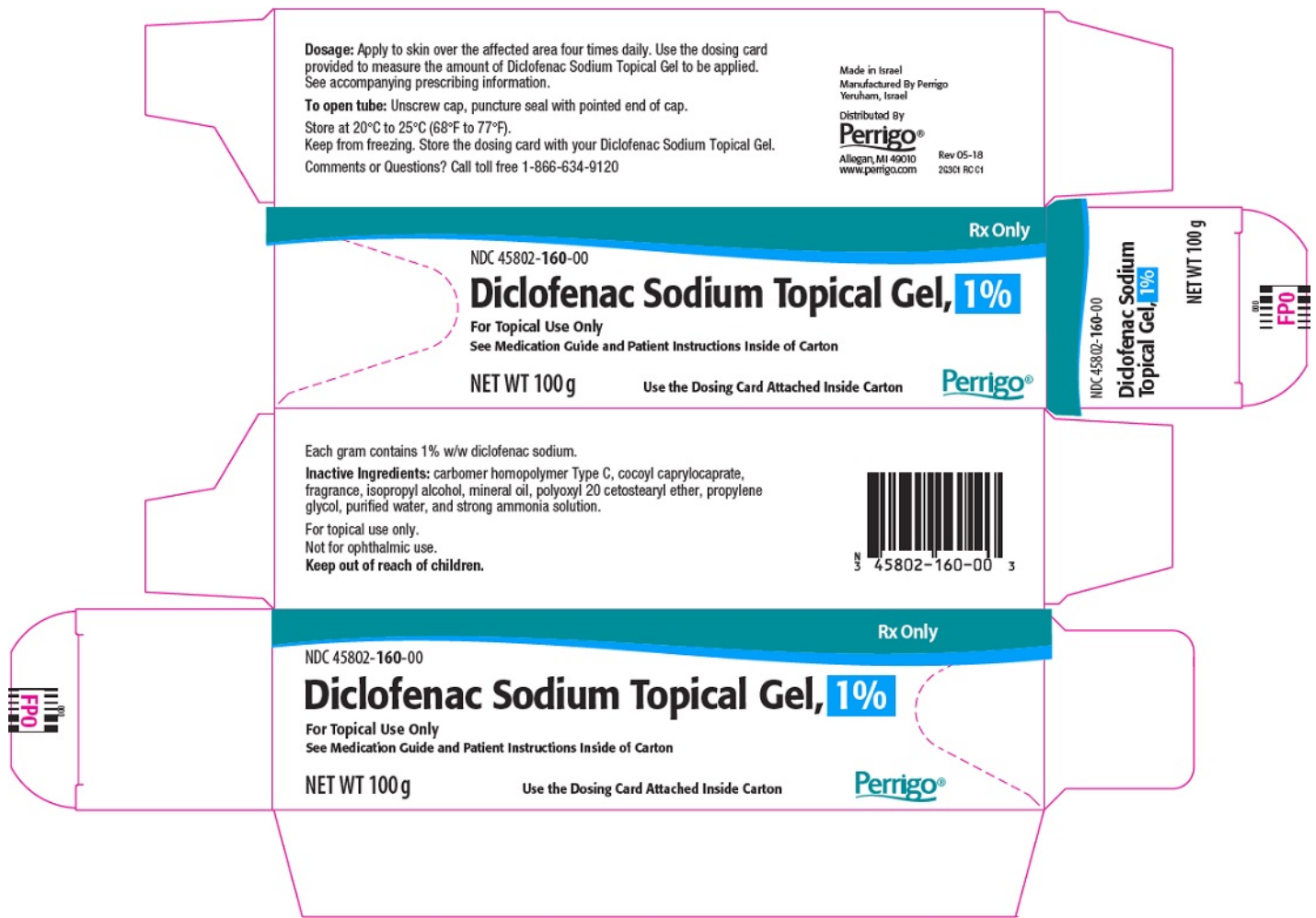

DICLOFENAC SODIUM

diclofenac sodium gel

Product Information

Product Type	HUMAN PRESCRIPTION DRUG	Item Code (Source)	NDC:45802-160
Route of Administration	TOPICAL		

Active Ingredient/Active Moiety

Ingredient Name	Basis of Strength	Strength
DICLOFENAC SODIUM (UNII: QTG126297Q) (DICLOFENAC - UNII:144O8QL0L1)	DICLOFENAC SODIUM	10 mg in 1 g

Inactive Ingredients

Ingredient Name	Strength
CARBOMER HOMOPOLYMER TYPE C (ALLYL PENTAERYTHRITOL CROSSLINKED) (UNII: 4Q93RCW27E)	
COCOYL CAPRYLOCAPRATE (UNII: 8D9H4QU99H)	
ISOPROPYL ALCOHOL (UNII: ND2M416302)	
MINERAL OIL (UNII: T5L8T28FGP)	
POLYOXYL 20 CETOSTEARYL ETHER (UNII: YRC528SWUY)	

PROPYLENE GLYCOL (UNII: 6DC9Q167V3)

WATER (UNII: 059QF0KO0R)

AMMONIA (UNII: 5138Q19F1X)

Packaging

#	Item Code	Package Description	Marketing Start Date	Marketing End Date
1	NDC:45802-160-00	1 in 1 CARTON	05/20/2019	05/01/2025
1		100 g in 1 TUBE; Type 0: Not a Combination Product		

Marketing Information

Marketing Category	Application Number or Monograph Citation	Marketing Start Date	Marketing End Date
ANDA	ANDA211253	05/20/2019	05/01/2025

Labeler - Padagis Israel Pharmaceuticals Ltd (600093611)

Revised: 4/2022

Padagis Israel Pharmaceuticals Ltd