

SODIUM CHLORIDE- sodium chloride injection

Baxter Healthcare Corporation

0.9% Sodium Chloride Injection, USP in Mini-Bag Plus Container

DESCRIPTION

0.9% Sodium Chloride Injection, USP in the **Mini-Bag Plus** Container System is a sterile, nonpyrogenic solution for intravenous administration after admixture with a single dose powdered or liquid (up to 10 mL) drug vial. It contains no antimicrobial agents. The nominal pH is 5.0 (4.5 to 7.0). Each 100 mL contains 900 mg of Sodium Chloride, USP (NaCl). The osmolarity is 308 mOsmol/L (calculated). Hydrochloric Acid, NF or Sodium Hydroxide, NF may be added for pH adjustment. It contains 154 mEq/L sodium and 154 mEq/L chloride.

The Mini-Bag Plus Container is a standard diluent container with an integral drug vial adaptor. It allows for drug admixture after connection to a **single dose** powdered or liquid (up to 10 mL) drug vial having a **13mm or 20mm closure**. A breakaway seal in the tube between the vial adaptor and the container is broken to allow transfer of the diluent into the vial and reconstitution of the drug. The Mini-Bag Plus product mechanically prohibits the transfer of contaminants into and out of the system during and after docking, minimizing environmental and personal exposure. The reconstituted drug is then transferred from the vial into the container diluent and mixed to result in an admixture for delivery to the patient.

The VIAFLEX Plastic Container is fabricated from a specially formulated polyvinyl chloride (PL 146 Plastic). Exposure to temperatures above 25°C/77°F during transport and storage will lead to minor losses in moisture content. Higher temperatures lead to greater losses. It is unlikely that these minor losses will lead to clinically significant changes within the expiration period. The amount of water that can permeate from inside the container into the overwrap is insufficient to affect the solution significantly. Solutions in contact with the plastic container can leach out certain chemical components from the plastic in very small amounts. However, biological testing was supportive of the safety of the plastic container materials.

CLINICAL PHARMACOLOGY

Sodium Chloride Injection, USP has value as a source of water and electrolytes. It is capable of inducing diuresis depending on the clinical condition of the patient.

INDICATIONS AND USAGE

0.9% Sodium Chloride Injection, USP is indicated as a source of water and electrolytes and may also be used as diluent for reconstitution of a powdered or liquid (up to 10 mL) drug product packaged in a vial with a 13mm or 20mm closure.

CONTRAINDICATIONS

None known.

WARNINGS

Hypersensitivity

Hypersensitivity and infusion reactions, including hypotension, pyrexia, tremor, chills, urticaria, rash, and pruritus have been reported with 0.9% Sodium Chloride Injection, USP.

Stop the infusion immediately if signs or symptoms of a hypersensitivity reaction develop, such as tachycardia, chest pain, dyspnea and flushing. Appropriate therapeutic countermeasures must be instituted as clinically indicated.

Electrolyte Imbalances

Fluid Overload

Depending on the volume and rate of infusion, and the patient's underlying clinical condition, the intravenous administration of Sodium Chloride Injection, USP can cause fluid disturbance such as overhydration/hypervolemia and congested states, including pulmonary congestion and edema.

Avoid 0.9% Sodium Chloride Injection, USP in patients with or at risk for fluid and/or solute overloading. If use cannot be avoided, fluid balance, electrolyte concentrations, and acid base balance, as needed and especially during prolonged use.

Hyponatremia

0.9% Sodium Chloride Injection, USP may cause hyponatremia. Hyponatremia can lead to acute hyponatremic encephalopathy characterized by headache, nausea, seizures, lethargy, and vomiting. Patients with brain edema are at particular risk of severe, irreversible and life-threatening brain injury.

The risk of hospital-acquired hyponatremia is increased in patients with cardiac or pulmonary failure, and in patients with non-osmotic vasopressin release (including SIADH) treated with high volume of Sodium Chloride Injection, USP.

The risk for hyponatremia is increased in pediatric patients, elderly patients, postoperative patients, in those with psychogenic polydipsia, and in patients treated with medications that increase the risk of hyponatremia (such as diuretics, certain antiepileptic and psychotropic medications). See DRUG INTERACTIONS.

Patients at increased risk for developing complications of hyponatremia such as hyponatremic encephalopathy, include pediatric patients, women (in particular premenopausal women), patients with hypoxemia, and patients with underlying central nervous system disease. Avoid 0.9% Sodium Chloride Injection, USP in patients with or at risk for hyponatremia. If use cannot be avoided, monitor serum sodium concentrations.

Rapid correction of hyponatremia is potentially dangerous with risk of serious neurologic complications. Brain adaptations reducing risk of cerebral edema make the brain vulnerable to injury when chronic hyponatremia is too rapidly corrected, which is known as osmotic demyelination syndrome (ODS). To avoid complications, monitor serum

sodium and chloride concentrations, fluid status, acid-base balance, and signs of neurologic complications.

Hypernatremia

Hypernatremia may occur with Sodium Chloride Injection, USP. Conditions that may increase the risk of hypernatremia, fluid overload and edema (central and peripheral), include patients with: primary hyperaldosteronism; secondary hyperaldosteronism associated with, for example, hypertension, congestive heart failure, liver disease (including cirrhosis), renal disease (including renal artery stenosis, nephrosclerosis); and pre-eclampsia.

Certain medications, such as corticosteroids or corticotropin, may also increase risk of sodium and fluid retention, see DRUG INTERACTIONS.

Avoid 0.9% Sodium Chloride Injection, USP in patients with, or at risk for, hypernatremia. If use cannot be avoided, monitor serum sodium concentrations.

Rapid correction of hypernatremia is potentially dangerous with risk of serious neurologic complications. Excessively rapid correction of hypernatremia is also associated with a risk for serious neurologic complications such as osmotic demyelination syndrome (ODS) with risk of seizures and cerebral edema.

For use only with a single dose powdered or liquid (up to 10 mL) drug vial with a 13mm or 20mm closure.

Do not administer unless drug is completely dissolved and drug vial is empty. Do not remove drug vial at any time prior to or during administration.

PRECAUTIONS

Patients with Severe Renal Impairment

Administration of 0.9% Sodium Chloride Injection, USP in patients with or at risk of severe renal impairment, may result in hypernatremia and/or fluid overload (see WARNINGS). Avoid Sodium Chloride Injection, USP in patients with severe renal impairment or conditions that may cause sodium and/or potassium retention, fluid overload, or edema. If use cannot be avoided, monitor patients with severe renal impairment for development of these adverse reactions.

Drug Interactions

Other Products that Affect Fluid and/or Electrolyte Balance

Administration of Sodium Chloride Injection, USP to patients treated concomitantly with drugs associated with sodium and fluid retention, may increase the risk of hypernatremia and volume overload. Avoid use of Sodium Chloride Injection, USP in patients receiving such products, such as corticosteroids or corticotropin. If use cannot be avoided, monitor serum electrolytes, fluid balance and acid-base balance.

Lithium

Renal sodium and lithium clearance may be decreased during administration of Sodium Chloride Injection, USP. Monitor serum may result in increased lithium concentrations during concomitant use.

Renal sodium and lithium clearance may be increased during administration of Sodium Chloride Injection, USP. Monitor serum lithium concentrations during concomitant use.

Other Drugs that Increase the Risk of Hyponatremia

Administration of 0.9% Sodium Chloride Injection, USP in patients treated concomitantly with medications associated with hyponatremia may increase the risk of developing hyponatremia.

Avoid use of 0.9% Sodium Chloride Injection, USP in patients receiving products, such as diuretics, and certain antiepileptic and psychotropic medications. Drugs that increase the vasopressin effect reduce renal electrolyte free water excretion and may also increase the risk of hyponatremia following treatment with intravenous fluids. If use cannot be avoided, monitor serum sodium concentrations.

Pregnancy

There are no adequate and well controlled studies with Sodium Chloride Injection, USP, in pregnant women and animal reproduction studies have not been conducted with this drug. Therefore, it is not known whether Sodium Chloride Injection, USP can cause fetal harm when administered to a pregnant woman. Sodium Chloride Injection, USP should be given during pregnancy only if the potential benefit justifies the potential risk to the fetus.

Nursing Mothers

It is not known whether this drug is present in human milk. Because many drugs are present in human milk, caution should be exercised when Sodium Chloride Injection, USP is administered to a nursing woman.

Pediatric Use

The use of Sodium Chloride Injection, USP in pediatric patients is based on clinical practice. (See **DOSAGE AND ADMINISTRATION.**)

Closely monitor plasma electrolyte concentrations in pediatric patients who may have impaired ability to regulate fluids and electrolytes. In very low birth weight infants, excessive or rapid administration of Sodium Chloride Injection, USP may result in increased serum osmolality and risk of intracerebral hemorrhage.

Children (including neonates and older children) are at increased risk of developing hyponatremia as well as for developing hyponatremic encephalopathy.

Geriatric Use

Geriatric patients are at increased risk of developing electrolyte imbalances. Sodium Chloride Injection, USP is known to be substantially excreted by the kidney, and the risk of toxic reactions to this drug may be greater in patients with impaired renal function.

Therefore, dose selection for an elderly patient should be cautious, usually starting at the low end of the dosing range, reflecting the greater frequency of decreased hepatic, renal, or cardiac function, and of concomitant disease or other drug therapy. Consider monitoring renal function in elderly patients.

ADVERSE REACTIONS

Post-Marketing Adverse Reactions

The following adverse reactions have been identified during postapproval use of 0.9% Sodium Chloride Injection, USP. Because these reactions are reported voluntarily from a population of uncertain size, it is not always possible to reliably estimate their frequency or establish a causal relationship to drug exposure.

The following adverse reactions have been reported in the post-marketing experience during use of 0.9% Sodium Chloride Injection, USP and include the following:

Hypersensitivity reactions: hypersensitivity/infusion reactions, including hypotension, pyrexia, tremor, chills, urticaria, rash, and pruritus.

General disorders and administration site conditions: infusion site reactions, such as infusion site erythema, injection site streaking, burning sensation, and infusion site urticaria.

Metabolism and nutrition disorders: hypernatremia, hyperchloremic metabolic acidosis, and hyponatremia, which may be symptomatic.

Nervous System Disorders: Hyponatremic encephalopathy.

If an adverse reaction does occur, discontinue the infusion, evaluate the patient, institute appropriate therapeutic countermeasures and save the remainder of the fluid for examination if deemed necessary.

OVERDOSAGE

Excessive administration of:

- 0.9% Sodium Chloride Injection, USP can cause hypernatremia.
- 0.9% Sodium Chloride Injection, USP can cause fluid overload (which can lead to pulmonary and/or peripheral edema). See WARNINGS and ADVERSE REACTIONS.

When assessing an overdose, any additives in the solution must also be considered. The effects of an overdose may require immediate medical attention and treatment.

Interventions include discontinuation of Sodium Chloride Injection, USP administration, dose reduction, and other measures as indicated for the specific clinical constellation (e.g., monitoring of fluid balance, electrolyte concentrations and acid base balance).

DOSAGE AND ADMINISTRATION

Important Administration Instructions

- 0.9 % Sodium Chloride Injection, USP is intended for intravenous administration using sterile equipment.
- Do not connect flexible plastic containers in series in order to avoid air embolism due to possible residual air contained in the primary container.
- Set the vent to the closed position on a vented intravenous administration set to prevent air embolism.

- Use a dedicated line without any connections to avoid air embolism.
- Do not pressurize intravenous solutions contained in flexible plastic containers to increase flow rates.
- Prior to infusion, visually inspect the solution for particulate matter and discoloration. The solution should be clear and there should be no precipitates. Do not administer unless solution is clear, and container is undamaged.

Dosing Information

The choice of product, dosage, volume, rate, and duration of administration is dependent upon the age, weight and clinical condition of the patient and concomitant therapy, and administration should be determined by a healthcare provider experienced in intravenous fluid therapy.

DIRECTIONS FOR USE

To Open

Tear overwrap down side at slit and remove solution container. Visually inspect the container. If the outlet port protector is damaged, detached, or not present, discard container as solution path sterility may be impaired. Some opacity of the plastic due to moisture absorption during the sterilization process may be observed. This is normal and does not affect the solution quality or safety. The opacity will diminish gradually.

Prior to use, check that the vial adaptor cover is intact. Check the solution container for minute leaks by squeezing inner bag firmly. If leaks are found or if the vial adaptor cover is not intact, discard product as sterility may be impaired.

To Assemble and Reconstitute

See diagram for detailed instructions.

Mini-Bag Plus Container Directions

Only For Single Dose Powdered or Liquid (up to 10 mL) Drug Vials with 13mm or 20mm Closures

Use Aseptic Technique

Assembly

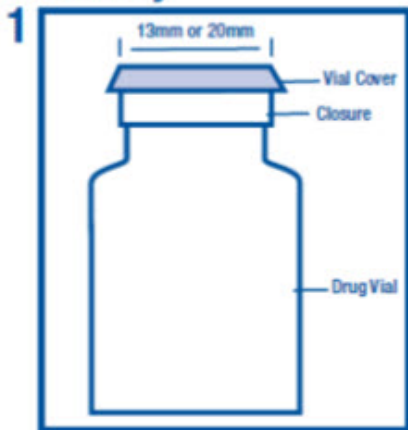

- Remove vial cover.
- Disinfect stopper.



- Peel off foil cover.
- Inspect adaptor for moisture.
- Discard if found.

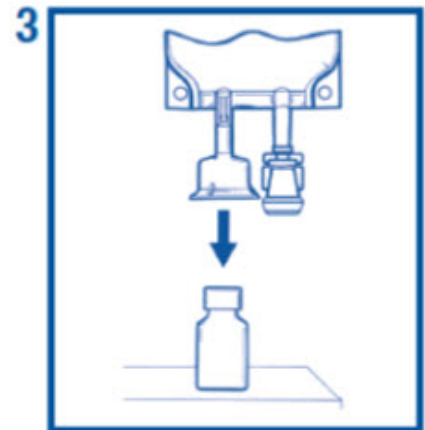

- Place vial upright.
- Hold firmly.
- Push adaptor down until vial snaps in place.
- DO NOT TWIST.

Reconstitution

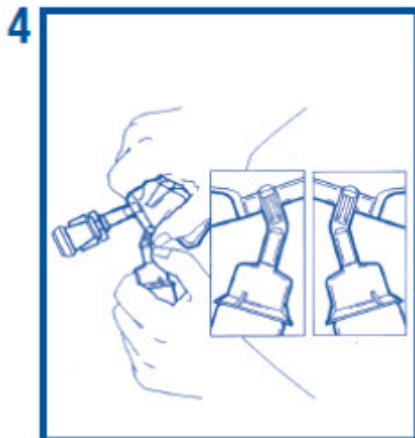

- Squeeze the bag and check vial.
- Use only if vial is fully seated and dry.
- With vial in an upright position break the seal by fully bending back and forth until a clear gap is observed in the breakaway seal.

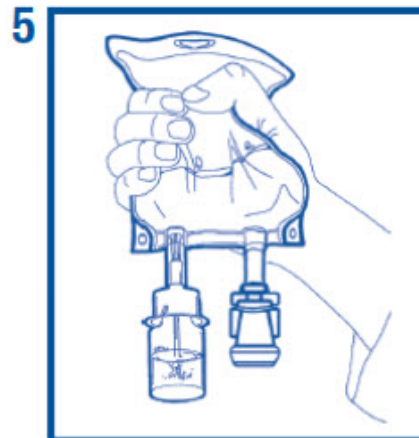

- For liquid drug vials proceed directly to Step 6. For powdered drug vials:
- Hold bag with vial down.
- Squeeze solution into vial until half full.
- Shake to suspend drug in solution.

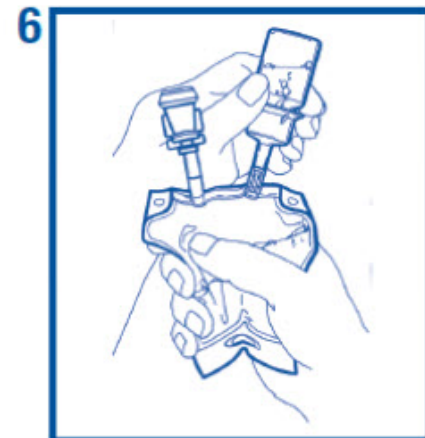

- Hold bag with vial upside down.
- Squeeze bag to force air into vial.
- Release to drain suspended drug from vial.
- Repeat steps 5 and 6 until vial is empty of drug and solution is thoroughly mixed. Ensure drug is completely dissolved. Do Not Remove Drug Vial.

- 7 → Remove port protector. Attach administration set per its directions.¶
- 8 → Hang container on I.V. pole and prime set per directions. Ensure that vial is empty of drug and solution. Repeat step 6 if drug and solution remain in vial.↵
Warning: Do not use in series connections.¶
- 9 → Administer medication per institutional practices.¶
- 10 → Use within specified time for drug stability.¶
- 11 → Discard unused portion.¶

HOW SUPPLIED

0.9% Sodium Chloride Injection, USP is a sterile solution supplied in Mini-Bag Plus Containers. The product is available as single packs (1 unit per overpouch). Table 1 lists single pack presentation compatible with vials with a 13 mm closure, and Table 2 lists single pack presentation compatible with vials with a 20 mm closure.

Table 1. Presentations of 0.9% Sodium Chloride Injection Compatible with Vials with a 13 mm Closure

Product Description	Size	Vial Adaptor Size	Configuration	Code	NDC
0.9% Sodium Chloride Injection, USP	50 mL	13 mm	single pack	EZPB0038LF	0338-0160-01
	100 mL	13 mm	single pack	EZPB0039LF	0338-0162-01

Table 2. Presentations of 0.9% Sodium Chloride Injection Compatible with Vials with a 20 mm Closure

Product Description	Size	Vial Adaptor Size	Configuration	Code	NDC
0.9% Sodium Chloride Injection, USP	50 mL	20 mm	single pack	EZPB0042LF	0338-0164-01
	100 mL	20 mm	single pack	EZPB0043LF	0338-0166-01

Minimize exposure of 0.9% Sodium Chloride Injection to heat. Avoid excessive heat. Store at room temperature (25°C (77°F)).

Manufactured by, Packed by, Distributed by:

Baxter Healthcare Corporation
Deerfield, IL 60015 USA

Baxter, Mini-Bag Plus and Viaflex are trademarks of Baxter International Inc.

CB-30-02-787
Rev. December 2022

PACKAGE/LABEL PRINCIPAL DISPLAY PANEL

BREAK SEAL AND MIX BEFORE USE

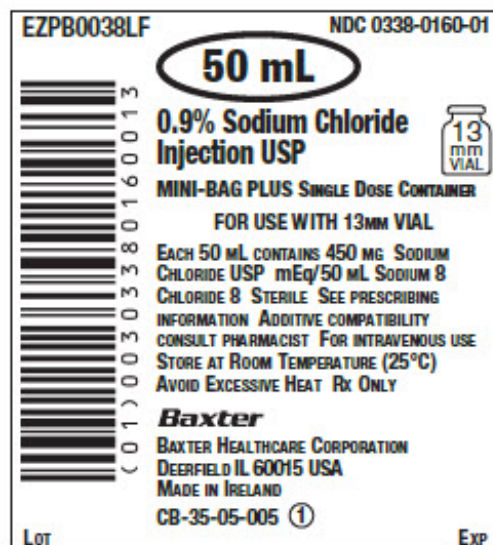

BREAK SEAL AND MIX BEFORE USE

EZPB0038LF

NDC 0338-0160-01

50 mL

0.9% Sodium Chloride Injection USP

MINI-BAG Plus Single Dose Container

FOR USE WITH 13mm VIAL

1 Symbol

13

mm

VIAL

Each 50 mL contains 450 mg Sodium Chloride USP mEq/50 mL Sodium 8 Chloride 8 Sterile See prescribing information Additive compatibility consult pharmacist For intravenous use Store at Room Temperature (25°C) Avoid Excessive Heat Rx Only

Baxter Logo

Baxter Healthcare Corporation

Deerfield, IL 60015 USA

Made in Ireland
CB-35-05-005 (1)

Bar Code
(01)00303380160013

Lot
Exp

BREAK SEAL AND MIX BEFORE USE

EZPB0042LF NDC 0338-0164-01

50 mL

0.9% Sodium Chloride Injection USP

MINI-BAG PLUS SINGLE DOSE CONTAINER

FOR USE WITH 20mm VIAL

EACH 50 mL CONTAINS 450 mg SODIUM CHLORIDE USP mEq/50 mL SODIUM 8 CHLORIDE 8 STERILE SEE PRESCRIBING INFORMATION ADDITIVE COMPATIBILITY CONSULT PHARMACIST FOR INTRAVENOUS USE STORE AT ROOM TEMPERATURE (25°C) AVOID EXCESSIVE HEAT RX ONLY

Baxter

BAXTER HEALTHCARE CORPORATION
DEERFIELD IL 60015 USA
MADE IN IRELAND
CB-35-05-006 ①

Lot Exp

BREAK SEAL AND MIX BEFORE USE

EZPB0042LF
NDC 0338-0164-01

50 mL

0.9% Sodium Chloride Injection USP
MINI-BAG PLUS SINGLE DOSE CONTAINER

FOR USE WITH 20mm VIAL

1 Symbol
20
mm
VIAL

Each 50 mL contains 450 mg Sodium Chloride USP mEq/50 mL Sodium 8 Chloride 8 Sterile See prescribing information Additive compatibility consult pharmacist For intravenous use Store at Room Temperature (25°C)

Avoid Excessive Heat Rx Only

Baxter Logo
Baxter Healthcare Corporation
Deerfield, IL 60015 USA
Made in Ireland
CB-35-05-006 (1)

Bar Code
(01)00303380164011

LOT
EXP

BREAK SEAL AND MIX BEFORE USE

EZPB0039LF NDC 0338-0162-01

100 mL

0.9% Sodium Chloride Injection USP

MINI-BAG PLUS SINGLE DOSE CONTAINER
FOR USE WITH 13mm VIAL

EACH 100 mL CONTAINS 900 mg SODIUM CHLORIDE USP mEq/100 mL SODIUM 15 CHLORIDE 15 STERILE SEE PRESCRIBING INFORMATION ADDITIVE COMPATIBILITY CONSULT PHARMACIST FOR INTRAVENOUS USE STORE AT ROOM TEMPERATURE (25°C) AVOID EXCESSIVE HEAT Rx ONLY

Baxter
BAXTER HEALTHCARE CORPORATION
DEERFIELD IL 60015 USA
MADE IN IRELAND
CB-35-05-007 ①

LOT _____ EXP _____

BREAK SEAL AND MIX BEFORE USE

EZPB0039LF
NDC 0338-0162-01

1000 mL

0.9% Sodium Chloride Injection USP
MINI-BAG PLUS SINGLE DOSE CONTAINER

FOR USE WITH 13mm VIAL

1 Symbol
13
mm
VIAL

Each 100 mL contains 900 mg Sodium Chloride USP mEq/100 mL Sodium 15

Chloride 15 Sterile See prescribing
information Additive compatibility
consult pharmacist For intravenous use
Store at Room Temperature (25°C)
Avoid Excessive Heat Rx Only

Baxter Logo

Baxter Healthcare Corporation

Deerfield, IL 60015 USA

Made in Ireland

CB-35-05-007 (1)

Bar Code

(01)00303380162017

LOT

EXP

BREAK SEAL AND MIX BEFORE USE

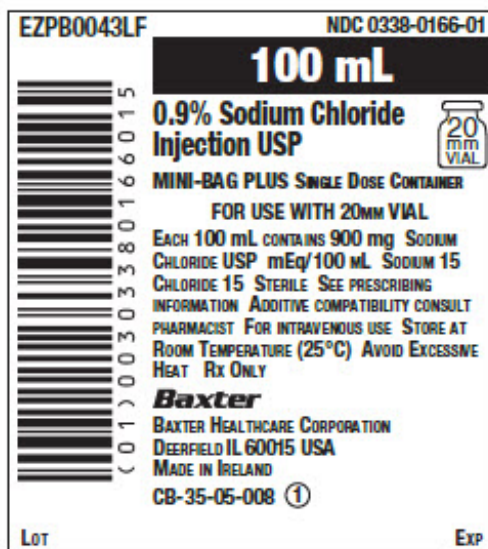

BREAK SEAL AND MIX BEFORE USE

EZPB0043LF

NDC 0338-0166-01

1000 mL

**0.9% Sodium Chloride
Injection USP**

MINI-BAG PLUS SINGLE DOSE CONTAINER

FOR USE WITH 20mm VIAL

1 Symbol

20

mm

VIAL

Each 100 mL contains 900 mg Sodium Chloride USP mEq/100 mL Sodium 15 Chloride 15 Sterile See prescribing information Additive compatibility consult pharmacist For intravenous use Store at Room Temperature (25°C) Avoid Excessive Heat Rx Only

Baxter Logo

Baxter Healthcare Corporation

Deerfield, IL 60015 USA

Made in Ireland

CB-35-05-008 (1)

Bar Code

(01)00303380166015

LOT

EXP

SODIUM CHLORIDE

sodium chloride injection

Product Information

Product Type	HUMAN PRESCRIPTION DRUG	Item Code (Source)	NDC:0338-0160
Route of Administration	INTRAVENOUS		

Active Ingredient/Active Moiety

Ingredient Name	Basis of Strength	Strength
SODIUM CHLORIDE (UNII: 451W47IQ8X) (SODIUM CATION - UNII:LYR4M0NH37, CHLORIDE ION - UNII:Q32ZN48698)	SODIUM CHLORIDE	450 mg in 100 mL

Inactive Ingredients

Ingredient Name	Strength
WATER (UNII: 059QF0KO0R)	

Packaging

#	Item Code	Package Description	Marketing Start Date	Marketing End Date
1	NDC:0338-0160-01	30 in 1 CARTON	12/07/2022	
1		50 mL in 1 BAG; Type 0: Not a Combination Product		

Marketing Information

Marketing Category	Application Number or Monograph Citation	Marketing Start Date	Marketing End Date
NDA	NDA020178	12/07/1992	

SODIUM CHLORIDE

sodium chloride injection

Product Information

Product Type	HUMAN PRESCRIPTION DRUG	Item Code (Source)	NDC:0338-0164
Route of Administration	INTRAVENOUS		

Active Ingredient/Active Moiety

Ingredient Name	Basis of Strength	Strength
SODIUM CHLORIDE (UNII: 451W47IQ8X) (SODIUM CATION - UNII:LYR4M0NH37, CHLORIDE ION - UNII:Q32ZN48698)	SODIUM CHLORIDE	450 mg in 100 mL

Inactive Ingredients

Ingredient Name	Strength
WATER (UNII: 059QF0KO0R)	

Packaging

#	Item Code	Package Description	Marketing Start Date	Marketing End Date
1	NDC:0338-0164-01	30 in 1 CARTON	12/07/2022	
1		50 mL in 1 BAG; Type 0: Not a Combination Product		

Marketing Information

Marketing Category	Application Number or Monograph Citation	Marketing Start Date	Marketing End Date
NDA	NDA020178	12/07/1992	

SODIUM CHLORIDE

sodium chloride injection

Product Information

Product Type	HUMAN PRESCRIPTION DRUG	Item Code (Source)	NDC:0338-0162
--------------	-------------------------	--------------------	---------------

Route of Administration	INTRAVENOUS			
Active Ingredient/Active Moiety				
	Ingredient Name	Basis of Strength	Strength	
	SODIUM CHLORIDE (UNII: 451W47IQ8X) (SODIUM CATION - UNII:LYR4M0NH37, CHLORIDE ION - UNII:Q32ZN48698)	SODIUM CHLORIDE	900 mg in 100 mL	
Inactive Ingredients				
	Ingredient Name	Strength		
	WATER (UNII: 059QF0KO0R)			
Packaging				
#	Item Code	Package Description	Marketing Start Date	Marketing End Date
1	NDC:0338-0162-01	30 in 1 CARTON	12/07/2022	
1		100 mL in 1 BAG; Type 0: Not a Combination Product		
Marketing Information				
	Marketing Category	Application Number or Monograph Citation	Marketing Start Date	Marketing End Date
	NDA	NDA020178	12/07/1992	

SODIUM CHLORIDE			
sodium chloride injection			
Product Information			
Product Type	HUMAN PRESCRIPTION DRUG	Item Code (Source)	NDC:0338-0166
Route of Administration	INTRAVENOUS		
Active Ingredient/Active Moiety			
	Ingredient Name	Basis of Strength	Strength
	SODIUM CHLORIDE (UNII: 451W47IQ8X) (SODIUM CATION - UNII:LYR4M0NH37, CHLORIDE ION - UNII:Q32ZN48698)	SODIUM CHLORIDE	900 mg in 100 mL
Inactive Ingredients			
	Ingredient Name	Strength	
	WATER (UNII: 059QF0KO0R)		

Packaging

#	Item Code	Package Description	Marketing Start Date	Marketing End Date
1	NDC:0338-0166-01	30 in 1 CARTON	12/07/2022	
1		100 mL in 1 BAG; Type 0: Not a Combination Product		

Marketing Information

Marketing Category	Application Number or Monograph Citation	Marketing Start Date	Marketing End Date
NDA	NDA020178	12/07/1992	

Labeler - Baxter Healthcare Corporation (005083209)

Establishment

Name	Address	ID/FEI	Business Operations
Baxter Healthcare S.A.		988899845	ANALYSIS(0338-0160, 0338-0164, 0338-0162, 0338-0166) , LABEL(0338-0160, 0338-0164, 0338-0162, 0338-0166) , MANUFACTURE(0338-0160, 0338-0164, 0338-0162, 0338-0166) , PACK(0338-0160, 0338-0164, 0338-0162, 0338-0166) , STERILIZE(0338-0160, 0338-0164, 0338-0162, 0338-0166)

Establishment

Name	Address	ID/FEI	Business Operations
Baxter Healthcare Corporation		091171389	ANALYSIS(0338-0160, 0338-0164, 0338-0162, 0338-0166)

Establishment

Name	Address	ID/FEI	Business Operations
Baxter Healthcare Corporation		189326168	ANALYSIS(0338-0160, 0338-0164, 0338-0162, 0338-0166)

Establishment

Name	Address	ID/FEI	Business Operations
Baxter Healthcare Corporation		194684502	ANALYSIS(0338-0160, 0338-0164, 0338-0162, 0338-0166)

Establishment

Name	Address	ID/FEI	Business Operations
Baxter Healthcare Corporation		059140764	ANALYSIS(0338-0160, 0338-0164, 0338-0162, 0338-0166)